

# FM30C256

## 256Kb Data Collector



### Features

#### 256K bit Ferroelectric Nonvolatile RAM

- Organized as 32,768 x 8 bits
- High Endurance 10 Billion ( $10^{10}$ ) Read/Writes
- 10 year Data Retention
- NoDelay™ Writes
- Advanced High-Reliability Ferroelectric Process

#### Fast Two-wire Serial Interface

- Up to 1 MHz Maximum Bus Frequency
- Supports Legacy Timing for 100 kHz & 400 kHz
- Clock Registers Accessed via 2-wire Interface

#### Real-time Clock/Calendar

- Backup Current under 1  $\mu$ A
- Tracks Seconds through Centuries (BCD format)
- Tracks Leap Years through 2099
- Uses Standard 32.768 kHz Crystal (6pF)
- Software Calibration

#### System Supervisor

- Active-low Reset Output for  $V_{DD}$  Out-of-Tolerance
- Tamper Detect Input with Battery Backup and Time Stamp

### Description

The FM30C256 is a 256-kilobit data collection subsystem including nonvolatile RAM, timekeeping, CPU supervisor, and system tamper detection. Non-volatile RAM is provided by FRAM technology, which is ideal for collection data and requires no battery backup for nonvolatile storage. In other respects, it provides the same features as SRAM. FRAM performs write operations at bus speed with no write delays. Write cycles can be continuous without block limitations. In addition, it offers much higher write endurance than other nonvolatile memories. The FM30C256 supports up to  $10^{10}$  read/write cycles.

The FM30C256 also includes timekeeping with external battery backup. The timekeeper consists of registers that represent time and date information in BCD format. The clock includes a calibration mode that allows a software adjustment for timekeeping accuracy.

To maintain system data integrity, the FM30C256 provides a reset signal asserted when  $V_{DD}$  is out of tolerance. /RST remains active for 100 ms after  $V_{DD}$  returns to proper levels. The FM30C256 also provides a battery-backed tamper detect circuit that records a rising edge on the TIN input. A battery-backed flag is set when the event occurs, but can only be cleared by software.

The FM30C256 is provided in a 20-pin SOIC package and is guaranteed over an industrial temperature range of  $-40^{\circ}\text{C}$  to  $+85^{\circ}\text{C}$ .

### Pin Configuration

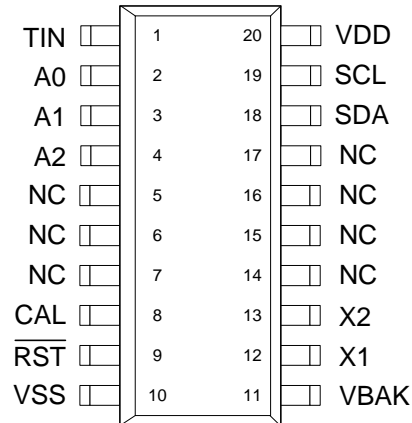

Pin Names	Function
TIN	Tamper Detect input
A0-A2	Device Select inputs
CAL	Clock Calibration output
/RST	Reset Output
X1, X2	Crystal Connections
SDA	Serial Data
SCL	Serial Clock
VDD	Supply Voltage 5V
VBAK	Battery-Backup input
VSS	Ground

Ordering Information	
FM30C256-S	20-pin SOIC

This product conforms to specifications per the terms of the Ramtron standard warranty. Production processing does not necessarily include testing of all parameters.

**Ramtron International Corporation**  
 1850 Ramtron Drive, Colorado Springs, CO 80921  
 (800) 545-FRAM, (719) 481-7000, Fax (719) 481-7058

[www.ramtron.com](http://www.ramtron.com)

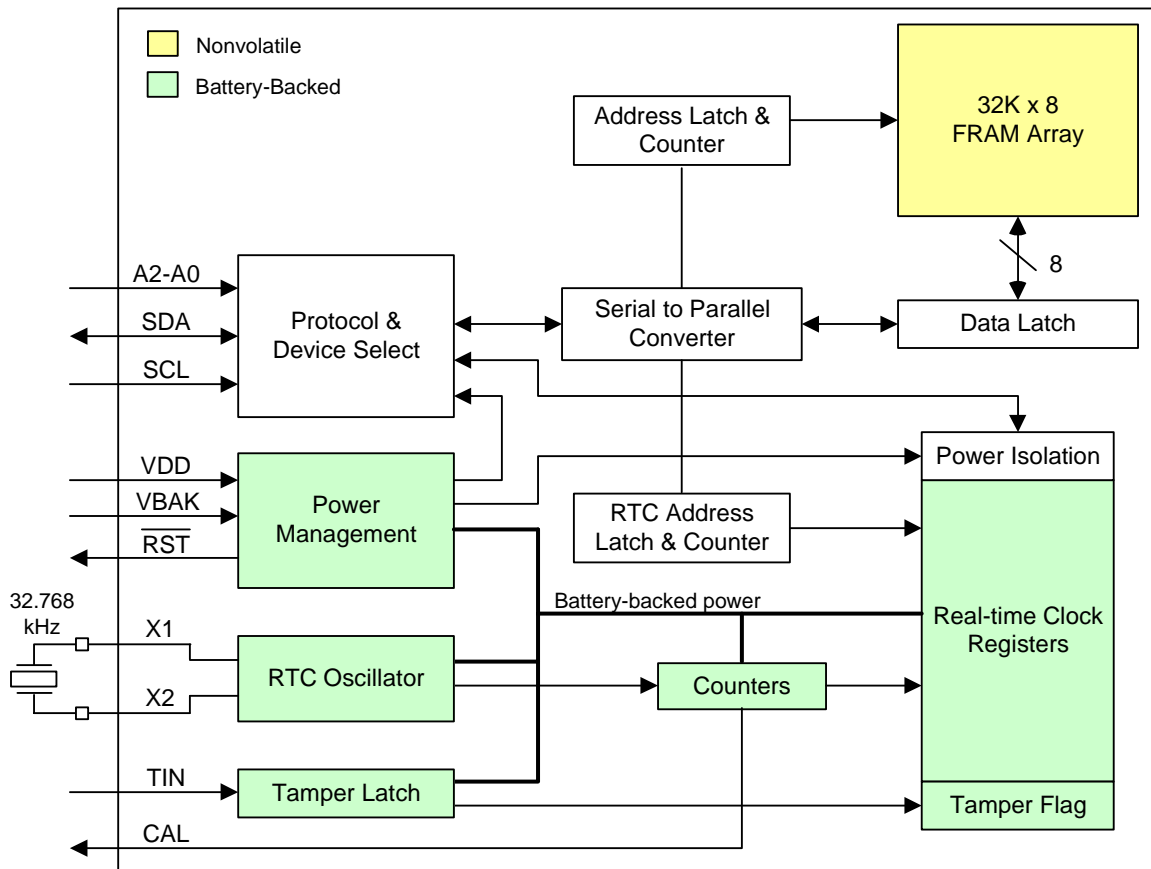

Figure 1. Block Diagram

Pin Descriptions

Pin Name	Type	Pin Description
A2-A0	Input	Device select inputs are used to address the part on a serial bus. To select the device, the address value on the three pins must match the corresponding bits contained in the device address. Note that these are not address pins for read/write operations. The address pins are pulled down internally.
TIN	Input	Tamper detect is a battery backed input that stores a 1 in the Flags/Control register when it detects a rising edge on the TIN pin.
CAL	Output	512 Hz square-wave output for clock calibration.
X1, X2	I/O	32.768 kHz crystal connection. When using an external oscillator source, use X2 as the oscillator input and leave X1 floating.
/RST	Output	Active low reset output (open drain)
SDA	I/O	Serial Data Address. This is a bi-directional line for the two-wire interface. It is open-drain and is intended to be wire-OR'd with other devices on the two-wire bus. The input buffer incorporates a Schmitt trigger for noise immunity and the output driver includes slope control for falling edges. A pull-up resistor is required.
SCL	Input	Serial Clock. The serial clock line for the two-wire interface. Data is clocked out of the part on the falling edge, and in on the rising edge. The SCL input also incorporates a Schmitt trigger input for noise immunity.
VBAK	Supply	Battery backup supply voltage (3V)
VDD	Supply	Supply Voltage (5V)
VSS	Supply	Ground
NC	-	No connect

## Overview

The FM30C256 data collector combines a 256Kb serial nonvolatile RAM with a real-time clock (RTC), a power monitor, and a tamper detect circuit. The FM30C256 integrates these complementary but distinct functions under a common interface in a single package. The memory and RTC functions are accessed using two different Device IDs and are conveniently packaged in a single monolithic device.

The memory is organized as 32Kx8 of FRAM and is accessed via the 2-wire Device ID 1010b while the remaining functions are accessed using Device ID 1101b. This allows the user to preserve addressing information when switching between memory and RTC functions. Modularity in software design is preserved as well.

The real-time clock function and the tamper detection is accessed under its own 2-wire device ID. This allows clock data to be read while maintaining the last (most recently used) memory address in the other device. The clock and tamper functions are controlled by 9 registers that are backed up by the external battery. Clock and tamper functions continue to operate from battery power when  $V_{DD}$  drops below the battery voltage.

In addition to the software-controlled functions, the FM30C256 also provides reset signal for an external microcontroller host. This signal is asserted when

$V_{DD}$  drops below the specified trip point ( $V_{TP}$ ). It remains asserted until  $V_{DD}$  returns above  $V_{TP}$  for the hold-off period ( $t_{RPU}$ ). The power monitor has no interaction with other software-controlled functions. All accesses to the device will be ignored when  $V_{DD} < V_{TP}$ .

## Memory Operation

When accessing the FM30C256, the user addresses 32,768 locations each with 8 data bits. These data bits are shifted in and out serially. The 32,768 addresses are accessed using the two-wire protocol, which includes a slave address (to distinguish from other non-memory devices), and an extended 16-bit address. The decoder uses only the lower 15 bits for accessing the memory. The upper address bit should be set to 0 for compatibility with larger devices in the future.

The memory is read or written at the speed of the two-wire bus. The interface protocol is described in the 2-Wire Interface section (page 9).

## RTC Register Map

The interface to clock and tamper functions is via 9 address locations mapped to a separate 2-wire device ID. The interface protocol is described below. The registers contain timekeeping data, control bits, and information flags. Detailed descriptions follow the Register Map (Table 1).

### Register Map Summary Table

Nonvolatile =  Battery-backed =

Address	D7	D6	D5	D4	D3	D2	D1	D0	Function	Range
9-F	ILLEGAL ADDRESSES									
8	10 years				years				Years	00-99
7	0	0	0	10 mo	months				Month	1-12
6	0	0	10 date		date				Date	1-31
5	0	0	0	0	0	day			Day	1-7
4	0	0	10 hours			hours			Hours	0-23
3	0	10 minutes			minutes			Minutes	0-59	
2	0	10 seconds			seconds			Seconds	0-59	
1	/OSCEN	TSEN	CALS	CAL4	CAL3	CAL2	CAL1	CAL0	CAL/Control	
0	Tamper	CF	reserved	reserved	TST	CAL	W	R	Flags/Control	

**Table 1. Register Map**

Address	Description																
<b>8h</b>	<b>Timekeeping – Years</b>																
	<table border="1"> <thead> <tr> <th>D7</th> <th>D6</th> <th>D5</th> <th>D4</th> <th>D3</th> <th>D2</th> <th>D1</th> <th>D0</th> </tr> </thead> <tbody> <tr> <td>10 year.3</td> <td>10 year.2</td> <td>10 year.1</td> <td>10 year.0</td> <td>Year.3</td> <td>Year.2</td> <td>Year.1</td> <td>Year.0</td> </tr> </tbody> </table>	D7	D6	D5	D4	D3	D2	D1	D0	10 year.3	10 year.2	10 year.1	10 year.0	Year.3	Year.2	Year.1	Year.0
	D7	D6	D5	D4	D3	D2	D1	D0									
	10 year.3	10 year.2	10 year.1	10 year.0	Year.3	Year.2	Year.1	Year.0									
Contains the lower two BCD digits of the year. Lower nibble contains the value for years; upper nibble contains the value for 10s of years. Each nibble operates from 0 to 9. The range for the register is 0-99.																	
<b>7h</b>	<b>Timekeeping – Months</b>																
	<table border="1"> <thead> <tr> <th>D7</th> <th>D6</th> <th>D5</th> <th>D4</th> <th>D3</th> <th>D2</th> <th>D1</th> <th>D0</th> </tr> </thead> <tbody> <tr> <td>0</td> <td>0</td> <td>0</td> <td>10 Month</td> <td>Month.3</td> <td>Month.2</td> <td>Month.1</td> <td>Month.0</td> </tr> </tbody> </table>	D7	D6	D5	D4	D3	D2	D1	D0	0	0	0	10 Month	Month.3	Month.2	Month.1	Month.0
	D7	D6	D5	D4	D3	D2	D1	D0									
	0	0	0	10 Month	Month.3	Month.2	Month.1	Month.0									
Contains the BCD digits for the month. Lower nibble contains the lower digit and operates from 0 to 9; upper nibble (one bit) contains the upper digit and operates from 0 to 1. The range for the register is 1-12.																	
<b>6h</b>	<b>Timekeeping – Date of the month</b>																
	<table border="1"> <thead> <tr> <th>D7</th> <th>D6</th> <th>D5</th> <th>D4</th> <th>D3</th> <th>D2</th> <th>D1</th> <th>D0</th> </tr> </thead> <tbody> <tr> <td>0</td> <td>0</td> <td>10 date.1</td> <td>10 date.0</td> <td>Date.3</td> <td>Date.2</td> <td>Date.1</td> <td>Date.0</td> </tr> </tbody> </table>	D7	D6	D5	D4	D3	D2	D1	D0	0	0	10 date.1	10 date.0	Date.3	Date.2	Date.1	Date.0
	D7	D6	D5	D4	D3	D2	D1	D0									
	0	0	10 date.1	10 date.0	Date.3	Date.2	Date.1	Date.0									
Contains the BCD digits for the date of the month. Lower nibble contains the lower digit and operates from 0 to 9; upper nibble contains the upper digit and operates from 0 to 3. The range for the register is 1-31.																	
<b>5h</b>	<b>Timekeeping – Day of the week</b>																
	<table border="1"> <thead> <tr> <th>D7</th> <th>D6</th> <th>D5</th> <th>D4</th> <th>D3</th> <th>D2</th> <th>D1</th> <th>D0</th> </tr> </thead> <tbody> <tr> <td>0</td> <td>0</td> <td>0</td> <td>0</td> <td>0</td> <td>Day.2</td> <td>Day.1</td> <td>Day.0</td> </tr> </tbody> </table>	D7	D6	D5	D4	D3	D2	D1	D0	0	0	0	0	0	Day.2	Day.1	Day.0
	D7	D6	D5	D4	D3	D2	D1	D0									
	0	0	0	0	0	Day.2	Day.1	Day.0									
Lower nibble contains a value that correlates to day of the week. Day of the week is a ring counter that counts from 1 to 7 then returns to 1. The user must assign meaning to the day value, as the day is not integrated with the date.																	
<b>4h</b>	<b>Timekeeping – Hours</b>																
	<table border="1"> <thead> <tr> <th>D7</th> <th>D6</th> <th>D5</th> <th>D4</th> <th>D3</th> <th>D2</th> <th>D1</th> <th>D0</th> </tr> </thead> <tbody> <tr> <td>0</td> <td>0</td> <td>10 hours.1</td> <td>10 hours.0</td> <td>Hours.3</td> <td>Hours.2</td> <td>Hours.1</td> <td>Hours.0</td> </tr> </tbody> </table>	D7	D6	D5	D4	D3	D2	D1	D0	0	0	10 hours.1	10 hours.0	Hours.3	Hours.2	Hours.1	Hours.0
	D7	D6	D5	D4	D3	D2	D1	D0									
	0	0	10 hours.1	10 hours.0	Hours.3	Hours.2	Hours.1	Hours.0									
Contains the BCD value of hours in 24-hour format. Lower nibble contains the lower digit and operates from 0 to 9; upper nibble (two bits) contains the upper digit and operates from 0 to 2. The range for the register is 0-23.																	
<b>3h</b>	<b>Timekeeping – Minutes</b>																
	<table border="1"> <thead> <tr> <th>D7</th> <th>D6</th> <th>D5</th> <th>D4</th> <th>D3</th> <th>D2</th> <th>D1</th> <th>D0</th> </tr> </thead> <tbody> <tr> <td>0</td> <td>10 min.2</td> <td>10 min.1</td> <td>10 min.0</td> <td>Min.3</td> <td>Min.2</td> <td>Min.1</td> <td>Min.0</td> </tr> </tbody> </table>	D7	D6	D5	D4	D3	D2	D1	D0	0	10 min.2	10 min.1	10 min.0	Min.3	Min.2	Min.1	Min.0
	D7	D6	D5	D4	D3	D2	D1	D0									
	0	10 min.2	10 min.1	10 min.0	Min.3	Min.2	Min.1	Min.0									
Contains the BCD value of minutes. Lower nibble contains the lower digit and operates from 0 to 9; upper nibble contains the upper minutes digit and operates from 0 to 5. The range for the register is 0-59.																	
<b>2h</b>	<b>Timekeeping – Seconds</b>																
	<table border="1"> <thead> <tr> <th>D7</th> <th>D6</th> <th>D5</th> <th>D4</th> <th>D3</th> <th>D2</th> <th>D1</th> <th>D0</th> </tr> </thead> <tbody> <tr> <td>0</td> <td>10 sec.2</td> <td>10 sec.1</td> <td>10 sec.0</td> <td>Seconds.3</td> <td>Seconds.2</td> <td>Seconds.1</td> <td>Seconds.0</td> </tr> </tbody> </table>	D7	D6	D5	D4	D3	D2	D1	D0	0	10 sec.2	10 sec.1	10 sec.0	Seconds.3	Seconds.2	Seconds.1	Seconds.0
	D7	D6	D5	D4	D3	D2	D1	D0									
	0	10 sec.2	10 sec.1	10 sec.0	Seconds.3	Seconds.2	Seconds.1	Seconds.0									
Contains the BCD value of seconds. Lower nibble contains the lower digit and operates from 0 to 9; upper nibble contains the upper digit and operates from 0 to 5. The range for the register is 0-59.																	

Address	Description																
<b>1h</b>	<b>CAL/Control</b>																
	<table border="1"> <thead> <tr> <th>D7</th> <th>D6</th> <th>D5</th> <th>D4</th> <th>D3</th> <th>D2</th> <th>D1</th> <th>D0</th> </tr> </thead> <tbody> <tr> <td>OSCE<sub>N</sub></td> <td>TSEN</td> <td>CALS</td> <td>CAL<sub>4</sub></td> <td>CAL<sub>3</sub></td> <td>CAL<sub>2</sub></td> <td>CAL<sub>1</sub></td> <td>CAL<sub>0</sub></td> </tr> </tbody> </table>	D7	D6	D5	D4	D3	D2	D1	D0	OSCE <sub>N</sub>	TSEN	CALS	CAL <sub>4</sub>	CAL <sub>3</sub>	CAL <sub>2</sub>	CAL <sub>1</sub>	CAL <sub>0</sub>
	D7	D6	D5	D4	D3	D2	D1	D0									
	OSCE <sub>N</sub>	TSEN	CALS	CAL <sub>4</sub>	CAL <sub>3</sub>	CAL <sub>2</sub>	CAL <sub>1</sub>	CAL <sub>0</sub>									
	/OSCEN	/Oscillator Enable. When set to 1, the oscillator is halted. When set to 0, the oscillator runs. Disabling the oscillator can save battery power during storage. On a power-up without battery, this bit is set to 1.															
TSEN	Time Stamp Enable. When set to 1, a Tamper Detect event will record the date and time of the event. On a power-up without battery, this bit is set to 0.																
CALS	Calibration sign. Determines if the calibration adjustment is applied as an addition to or as a subtraction from the time-base. Calibration is explained below.																
CAL <sub>4-0</sub>	These five bits control the calibration of the clock.																
<b>0h</b>	<b>Flags/Control</b>																
	<table border="1"> <thead> <tr> <th>D7</th> <th>D6</th> <th>D5</th> <th>D4</th> <th>D3</th> <th>D2</th> <th>D1</th> <th>D0</th> </tr> </thead> <tbody> <tr> <td>Tamper</td> <td>CF</td> <td>Reserved</td> <td>Reserved</td> <td>TST</td> <td>CAL</td> <td>W</td> <td>R</td> </tr> </tbody> </table>	D7	D6	D5	D4	D3	D2	D1	D0	Tamper	CF	Reserved	Reserved	TST	CAL	W	R
	D7	D6	D5	D4	D3	D2	D1	D0									
	Tamper	CF	Reserved	Reserved	TST	CAL	W	R									
	Tamper	Tamper Detect. This bit is set to 1 when rising edge is detected on the TIN pin. It can only be cleared to 0 by the user.															
	CF	Century Overflow Flag. This bit is set to a 1 when the values in the years register overflows from 99 to 00. This indicates a new century, such as going from 1999 to 2000 or 2099 to 2100. The user should record the new century information as needed. This bit is cleared to 0 when the Flag register is read. It is read-only for the user.															
	TST	Invokes factory test mode. Users should always set this bit to 0.															
	CAL	Calibration Mode. When set to 1, the clock enters calibration mode. When CAL is set to 0, the clock operates normally, and the CAL pin is driven low.															
	W	Write Time. Setting the W bit to 1 freezes updates of the timekeeping registers. The user can then write them with updated values. Setting the W bit to 0 causes the contents of the time registers to be transferred to the timekeeping counters.															
	R	Read Time. Setting the R bit to 1 copies a static image of the timekeeping registers and places them in a holding register. The user can then read them without concerns over changing values causing system errors. The R bit going from 0 to 1 causes the timekeeping capture, so the bit must be returned to 0 prior to reading again.															
Reserved	Reserved bits. Do not use. Should remain set to 0.																

## Real-time Clock Operation

The real-time clock (RTC) consists of an oscillator, divider, and a register system for accessing the information. It divides down the 32.768 kHz time-base and provides a resolution of seconds (1Hz) to the user. Static registers provide the user with read/write access to the time values. The synchronization of these registers with the timekeeper core is performed using R and W bits in register 0.

Changing the R bit from 0 to 1 causes a transfer of the timekeeping information to holding registers that can be read by the user. If a timekeeper update is pending when R is set, then the update will be completed prior to loading the registers. Another update cannot be performed until the R bit is cleared to 0.

Setting the W bit to 1 causes the timekeeper to freeze updates. Clearing it to 0 causes the values in the time

registers to be written into the timekeeper core. Users should be certain not to load invalid values, such as FFh, to the timekeeping registers.

Updates to the timekeeping core occur continuously except when frozen. A diagram of the timekeeping core follows.

### Backup Power

The real-time clock/calendar is intended for permanently powered operation. When the primary system power fails, the voltage on the VDD pin will drop. When VDD is less than the voltage on the VBAK pin, the clock will switch to the backup power supply. The clock operates at extremely low current in order to maximize battery life. However, an advantage of combining a clock function with FRAM is that the 256K memory data is not lost regardless of the backup power source.

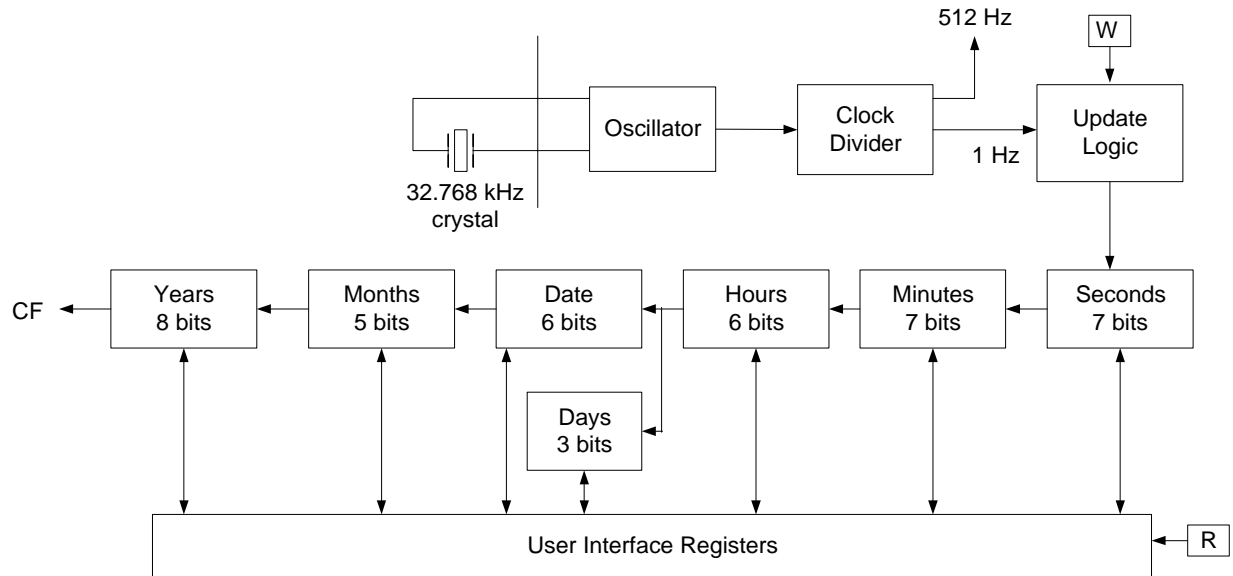

Figure 2. Real-time Clock Core Block Diagram

**Calibration**

When the CAL bit in register 0 is set to 1, the clock enters calibration mode. Calibration operates by applying a digital correction to the counter based on the frequency error. In CAL mode, the CAL pin is driven with a 512 Hz (nominal) square wave. Any measured deviation from 512 Hz is converted to an error in ppm. This error corresponds to a correction value that is then written by the user into the calibration register. The correction factors are listed in the table below.

Positive ppm errors require a negative adjustment that removes pulses. Negative ppm errors require a positive correction that adds pulses. Positive ppm adjustments have the CALS bit set to 1, where as negative ppm adjustments have CALS = 0. After calibration, the clock will have a maximum error of

$\pm 2.17$  ppm or  $\pm 0.09$  minutes per month at the calibrated temperature.

The calibration setting is battery backed and is stored in bits CAL.4-0. This value only can be written when the CAL bit is set to a 1. To exit the calibration mode, the user must clear the CAL bit to a 0. When the CAL bit is 0, the CAL pin will be driven low.

When the calibration mode is entered, the user can measure the frequency error on the CAL pin. This error expressed in ppm translates directly into timekeeping error. An offsetting calibration adjustment corrects this error. However, the correction is applied by adding or removing pulses on a periodic basis. Therefore, the correction will not appear on the 512 Hz output. The calibration correction must be applied using the lookup table below. The timekeeping accuracy can be verified by comparing the FM30C256 time to a reference source.

**Table 2. Calibration Adjustments**

<b>Positive Calibration for slow clocks: Calibration will achieve +/- 2.17 PPM after calibration</b>					
	Measured Frequency Range		Error Range (PPM)		Program Calibration Register to:
	Min	Max	Min	Max	
0	512.0000	511.9989	0	2.17	000000
1	511.9989	511.9967	2.18	6.51	100001
2	511.9967	511.9944	6.52	10.85	100010
3	511.9944	511.9922	10.86	15.19	100011
4	511.9922	511.9900	15.20	19.53	100100
5	511.9900	511.9878	19.54	23.87	100101
6	511.9878	511.9856	23.88	28.21	100110
7	511.9856	511.9833	28.22	32.55	100111
8	511.9833	511.9811	32.56	36.89	101000
9	511.9811	511.9789	36.90	41.23	101001
10	511.9789	511.9767	41.24	45.57	101010
11	511.9767	511.9744	45.58	49.91	101011
12	511.9744	511.9722	49.92	54.25	101100
13	511.9722	511.9700	54.26	58.59	101101
14	511.9700	511.9678	58.60	62.93	101110
15	511.9678	511.9656	62.94	67.27	101111
16	511.9656	511.9633	67.28	71.61	110000
17	511.9633	511.9611	71.62	75.95	110001
18	511.9611	511.9589	75.96	80.29	110010
19	511.9589	511.9567	80.30	84.63	110011
20	511.9567	511.9544	84.64	88.97	110100
21	511.9544	511.9522	88.98	93.31	110101
22	511.9522	511.9500	93.32	97.65	110110
23	511.9500	511.9478	97.66	101.99	110111
24	511.9478	511.9456	102.00	106.33	111000
25	511.9456	511.9433	106.34	110.67	111001
26	511.9433	511.9411	110.68	115.01	111010
27	511.9411	511.9389	115.02	119.35	111011
28	511.9389	511.9367	119.36	123.69	111100
29	511.9367	511.9344	123.70	128.03	111101
30	511.9344	511.9322	128.04	132.37	111110
31	511.9322	511.9300	132.38	136.71	111111

<b>Negative Calibration for fast clocks: Calibration will achieve +/- 2.17 PPM after calibration</b>					
	Measured Frequency Range		Error Range (PPM)		Program Calibration Register to:
	Min	Max	Min	Max	
0	512.0000	512.0011	0	2.17	000000
1	512.0011	512.0033	2.18	6.51	000001
2	512.0033	512.0056	6.52	10.85	000010
3	512.0056	512.0078	10.86	15.19	000011
4	512.0078	512.0100	15.20	19.53	000100
5	512.0100	512.0122	19.54	23.87	000101
6	512.0122	512.0144	23.88	28.21	000110
7	512.0144	512.0167	28.22	32.55	000111
8	512.0167	512.0189	32.56	36.89	001000
9	512.0189	512.0211	36.90	41.23	001001
10	512.0211	512.0233	41.24	45.57	001010



11	512.0233	512.0256	45.58	49.91	001011
12	512.0256	512.0278	49.92	54.25	001100
13	512.0278	512.0300	54.26	58.59	001101
14	512.0300	512.0322	58.60	62.93	001110
15	512.0322	512.0344	62.94	67.27	001111
16	512.0344	512.0367	67.28	71.61	010000
17	512.0367	512.0389	71.62	75.95	010001
18	512.0389	512.0411	75.96	80.29	010010
19	512.0411	512.0433	80.30	84.63	010011
20	512.0433	512.0456	84.64	88.97	010100
21	512.0456	512.0478	88.98	93.31	010101
22	512.0478	512.0500	93.32	97.65	010110
23	512.0500	512.0522	97.66	101.99	010111
24	512.0522	512.0544	102.00	106.33	011000
25	512.0544	512.0567	106.34	110.67	011001
26	512.0567	512.0589	110.68	115.01	011010
27	512.0589	512.0611	115.02	119.35	011011
28	512.0611	512.0633	119.36	123.69	011100
29	512.0633	512.0656	123.70	128.03	011101
30	512.0656	512.0678	128.04	132.37	011110
31	512.0678	512.0700	132.38	136.71	011111

### Tamper Detection and Time Stamp

The TIN pin is a battery-backed input that is used to detect a tamper event in the system. When a rising edge occurs on TIN, this Tamper Detect event is recorded in the MSB of register 0. This action will occur only when either  $V_{BAK}$  or  $V_{DD}$  is applied. Any further activity on TIN, such as a falling edge, will be ignored. The user is responsible for reading and clearing the Tamper flag. Clearing the Tamper flag allows the TIN to detect another rising edge. The tamper flag can only be read or cleared when  $V_{DD} \geq 4.5V$ . On a power-up without battery, this bit is set to zero.

The tamper input TIN can be used to timestamp the exact time a tamper event occurs. This feature can be enabled by setting the timestamp enable bit TSEN in the calibration control register (RTC address 1, bit D6). At power-up, TSEN is cleared and must be set by the user. When a rising edge occurs on TIN and the TSEN bit is set, the date and time of the event will be recorded. The current time is loaded into the timekeeping registers. When the system is checked for a tamper event, the time of the event can be read. After a tamper event, the timekeeping registers can be overwritten if the R bit is set before reading the timekeeping registers. To prevent overwriting the timestamp, the control register should be read first to check that the tamper bit is set. If it is set, the timekeeping registers should be read to collect the time of the last tamper event. Checking for a tamper event before setting the R bit will ensure accurate

tamper timestamp information. If the TSEN bit is not set, then a rising edge on TIN will not trigger a timestamp.

The TIN input provides an internal pulldown resistance  $R_{TIN}$  when the Tamper flag is reset to zero. Once a tamper event occurs, the Tamper flag is set to a 1 and the input resistance  $R_{TIN}$  is electrically removed.

### System Reset Control

The /RST pin allows the user to easily control a system level reset function. It is an open drain output and requires an external pullup resistor to  $V_{DD}$  for proper operation. When  $V_{DD}$  is within the specified operating range, /RST output is tri-stated and pulled to  $V_{DD}$  by the external resistor. If  $V_{DD}$  drops below the reset trip point voltage level ( $V_{TP}$ ) and remains below this level for the  $V_{TP}$  noise immunity duration ( $t_{RNR}$ ), the /RST pin will be driven low. It will continue to drive low until  $V_{DD}$  falls below the  $V_{RST}$  level. When  $V_{DD}$  rises again above  $V_{TP}$ , /RST will continue to drive low for a duration ( $t_{RPU}$ ) to ensure a robust system reset at a reliable  $V_{DD}$  level. After  $t_{RPU}$  has been met, the /RST pin tri-states and is pulled high by the external pullup resistor. Refer to the figure on page 16 for a graphical description of the /RST function and timing.



## Two-wire Interface

The FM30C256 employs an industry standard two-wire bus that is familiar to many users and for convenience is described in this section.

The FM30C256 is unique since it incorporates two logical devices in one chip. Each logical device can be accessed individually. One is a memory device. It has a Slave Address (Slave ID = 1010b) that operates the same as a stand-alone memory device. The second device is a real-time clock and tamper detect which share a unique Slave Address (Slave ID = 1101b).

By convention, any device that is sending data onto the bus is the transmitter while the target device for this data is the receiver. The device that is controlling the bus is the master. The master is responsible for generating the clock signal for all operations. Any device on the bus that is being controlled is a slave. The FM30C256 is always a slave device.

The bus protocol is controlled by transition states in the SDA and SCL signals. There are four conditions: Start, Stop, Data bit, and Acknowledge. Figure 4 illustrates the signal conditions that specify the four states. Detailed timing diagrams are shown in the electrical specifications.

### Start Condition

A Start condition is indicated when the bus master drives SDA from high to low while the SCL signal is high. All read and write transactions begin with a Start condition. An operation in progress can be aborted by asserting a Start condition at any time. Aborting an operation using the Start condition will ready the FM30C256 for a new operation.

If the power supply drops below the specified VDD minimum during operation, the system should issue a Start condition prior to performing another operation.

### Stop Condition

A Stop condition is indicated when the bus master drives SDA from low to high while the SCL signal is high. All operations must end with a Stop condition. If an operation is pending when a stop is asserted, the operation will be aborted. The master must have control of SDA (not a memory read) in order to assert a Stop condition.

### Data/Address Transfer

All data transfers (including addresses) take place while the SCL signal is high. Except under the two conditions described above, the SDA signal should not change while SCL is high.

### Acknowledge

The Acknowledge takes place after the 8<sup>th</sup> data bit has been transferred in any transaction. During this state the transmitter must release the SDA bus to allow the receiver to drive it. The receiver drives the SDA signal low to acknowledge receipt of the byte. If the receiver does not drive SDA low, the condition is a No-Acknowledge and the operation is aborted.

The receiver might fail to acknowledge for two distinct reasons. First is that a byte transfer fails. In this case, the No-Acknowledge ends the current operation so that the part can be addressed again. This allows the last byte to be recovered in the event of a communication error.

Second and most common, the receiver does not send an Acknowledge to deliberately terminate an operation. For example, during a read operation, the FM30C256 will continue to place data onto the bus as long as the receiver sends Acknowledges (and clocks). When a read operation is complete and no more data is needed, the receiver must not acknowledge the last byte. If the receiver acknowledges the last byte, this will cause the FM30C256 to attempt to drive the bus on the next clock while the master is sending a new command such as a Stop.

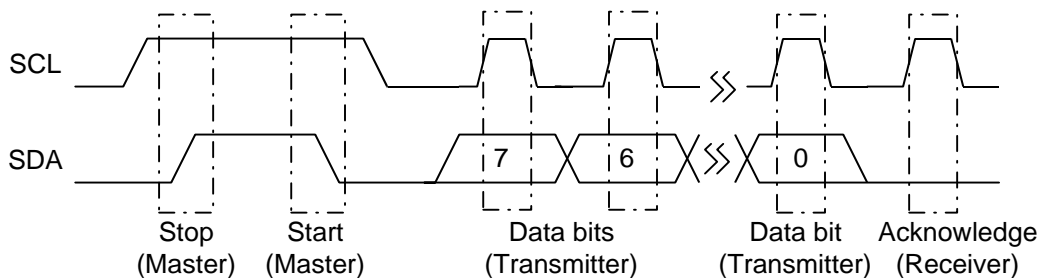

Figure 3. Data Transfer Protocol

**Slave Address**

The first byte that the FM30C256 expects after a Start condition is the slave address. As shown in Figure 4, the slave address contains the Slave ID, Device Select address, and a bit that specifies if the transaction is a read or a write.

The FM30C256 has two Slave Addresses (Slave IDs) associated with two logical devices. To access the memory device, bits 7-4 should be set to 1010b. See Figure 4. The other logical device within the FM30C256 is the real-time clock and tamper detect. To access this device, bits 7-4 of the slave address should be set to 1101b. A bus transaction with this slave address will not affect the memory in any way. See Figure 5.

The Slave ID bits allow other function types to reside on the 2-wire bus for a given device select address. The device select bits (bits 3-1) are used to select one of eight chips on a two-wire bus. They must match the corresponding value on the external address pins in order to select the device. Up to eight devices can reside on the same two-wire bus by assigning a different address to each device. Bit 0 is the read/write bit. A “1” indicates a read operation, and a “0” indicates a write operation.

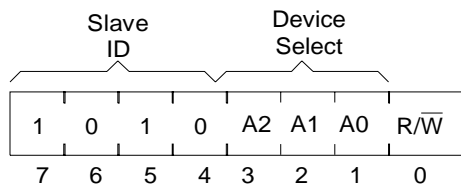

**Figure 4. Slave Address - Memory**

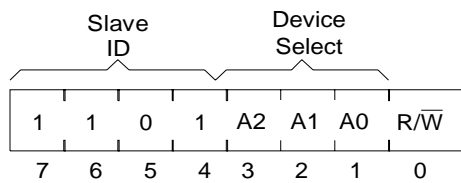

**Figure 5. Slave Address – RTC**

**Addressing Overview – Memory**

After the FM30C256 acknowledges the Slave Address, the master can place the memory address on the bus for a write operation. The address requires two bytes. The first is the MSB (upper byte). Since the device uses only 15 address bits, the value of the upper bit is a “don’t care”. Following the MSB is the LSB (lower byte) which contains the remaining eight

address bits. The address is latched internally. Each access causes the latched address to be incremented automatically. The current address is the value that is held in the latch, either a newly written value or the address following the last access. The current address will be held as long as power remains or until a new value is written. Accesses to the clock do not affect the current memory address. Reads always use the current address. A random read address can be loaded by beginning a write operation as explained below.

After transmission of each data byte, just prior to the Acknowledge, the FM30C256 increments the internal address. This allows the next sequential byte to be accessed with no additional addressing externally. After the last address (7FFFh) is reached, the address latch will roll over to 0000h. There is no limit to the number of bytes that can be accessed with a single read or write operation.

**Addressing Overview – RTC**

The RTC operates in a similar manner to the memory, except that it uses only one byte of address. The low four bits of address specify register 0-8, and the upper four bits are “don’t care”. Only addresses 0 through 8 should be loaded during an RTC write command. Loading addresses 9-F is an illegal condition and should not be attempted since unpredictable results could occur.

**Data Transfer**

After the address information has been transmitted, data transfer between the bus master and the FM30C256 begins. For a read, the FM30C256 will place 8 data bits on the bus then wait for an Acknowledge from the master. If the Acknowledge occurs, the FM30C256 will transfer the next byte. If the Acknowledge is not sent, the FM30C256 will end the read operation. For a write operation, the FM30C256 will accept 8 data bits from the master then send an Acknowledge. All data transfer occurs MSB (most significant bit) first.

**Memory Write Operation**

All memory writes begin with a Slave Address, then a memory address. The bus master indicates a write operation by setting the slave address LSB to a 0. After addressing, the bus master sends each byte of data to the memory and the memory generates an Acknowledge condition. Any number of sequential bytes may be written. If the end of the address range is reached internally, the address counter will wrap from 7FFFh to 0000h. Internally, the actual memory write occurs after the 8<sup>th</sup> data bit is transferred. It will be complete before the Acknowledge is sent. Therefore, if the user desires to abort a write without

altering the memory contents, this should be done using a Start or Stop condition prior to the 8<sup>th</sup> data

bit. Figures 6 and 7 illustrate a single- and multiple-writes to memory.

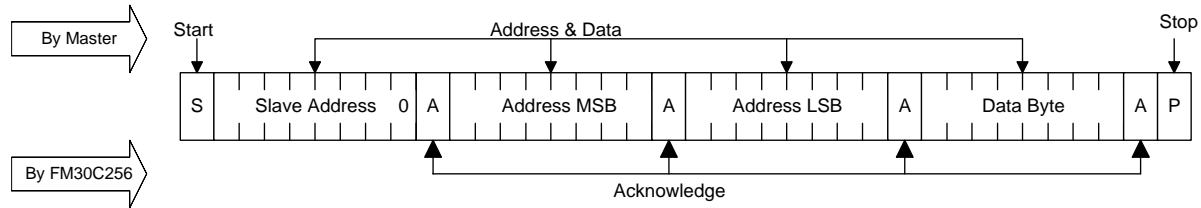

Figure 6. Single Byte Memory Write

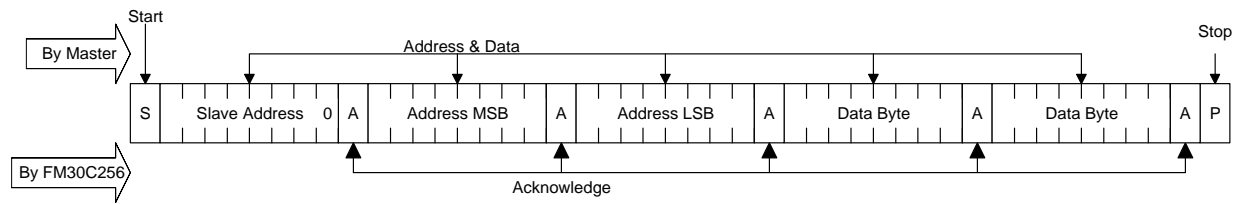

Figure 7. Multiple Byte Memory Write

**Memory Read Operation**

There are two types of memory read operations. They are current address read and selective address read. In a current address read, the FM30C256 uses the internal address latch to supply the address. In a selective read, the user performs a procedure to set the address to a specific value.

*Each time the bus master acknowledges a byte, this indicates that the FM30C256 should read out the next sequential byte.*

Current Address & Sequential Read

As mentioned above the FM30C256 uses an internal latch to supply the address for a read operation. A current address read uses the existing value in the address latch as a starting place for the read operation. The system reads from the address immediately following that of the last operation.

There are four ways to terminate a read operation. Failing to properly terminate the read will most likely create a bus contention as the FM30C256 attempts to read out additional data onto the bus. The four valid methods follow.

To perform a current address read, the bus master supplies a slave address with the LSB set to 1. This indicates that a read operation is requested. After receiving the complete device address, the FM30C256 will begin shifting data out from the current address on the next clock. The current address is the value held in the internal address latch.

1. The bus master issues a No-Acknowledge in the 9<sup>th</sup> clock cycle and a Stop in the 10<sup>th</sup> clock cycle. This is illustrated in the diagrams below. This is preferred.
2. The bus master issues a No-Acknowledge in the 9<sup>th</sup> clock cycle and a start in the 10<sup>th</sup>.
3. The bus master issues a Stop in the 9<sup>th</sup> clock cycle.
4. The bus master issues a Start in the 9<sup>th</sup> clock cycle.

If the internal address reaches 7FFFh, it will wrap around to 0000h on the next read cycle. Figures 8 and 9 show the proper operation for current address reads.

Beginning with the current address, the bus master can read any number of bytes. Thus, a sequential read is simply a current address read with multiple byte transfers. After each byte the internal address counter will be incremented.

Selective (Random) Read

There is a simple technique that allows a user to select a random address location as the starting point for a read operation. This involves using the first three bytes of a write operation to set the internal address followed by subsequent read operations.

To perform a selective read, the bus master sends out the slave address with the LSB set to 0. This specifies a write operation. According to the write protocol, the bus master then sends the address bytes that are loaded into the internal address latch. After the FM30C256 acknowledges the address, the bus master issues a Start condition. This simultaneously aborts the write operation and allows the read command to be issued with the slave address LSB set to a 1. The operation is now a read from the current address. Figure 10 shows the proper operation for a selective read.

**RTC Write Operation**

All RTC writes operate in a similar manner to memory writes. The distinction is that a different device ID is used and only one byte address is needed instead of two. Figure 11 illustrates a single byte write to the clock.

**RTC Read Operation**

As with writes, a read operation begins with the Slave Address. To perform a register read, the bus master supplies a Slave Address with the LSB set to 1. This indicates that a read operation is requested. After receiving the complete Slave Address, the FM30C256 will begin shifting data out from the current register address on the next clock. Auto-increment operates for the RTC address as with the memory address. A current address read for the RTC looks exactly like the memory except that the device ID is different. The FM30C256 contains two separate address registers, one for the 256K memory address and the other for the RTC register address. This allows the contents of one address register to be modified without affecting the current address of the other register. For example, this would allow an interrupted read to the memory while still providing fast access to an RTC register. A subsequent memory read will then continue from the memory address where it previously left off, without requiring the load of a new memory address. However, a write sequence always requires an address to be supplied.

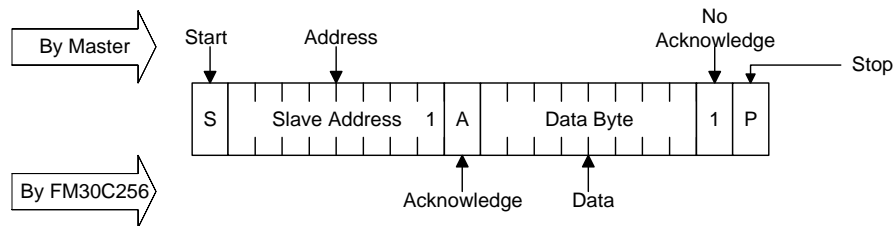

**Figure 8. Current Address Memory Read**

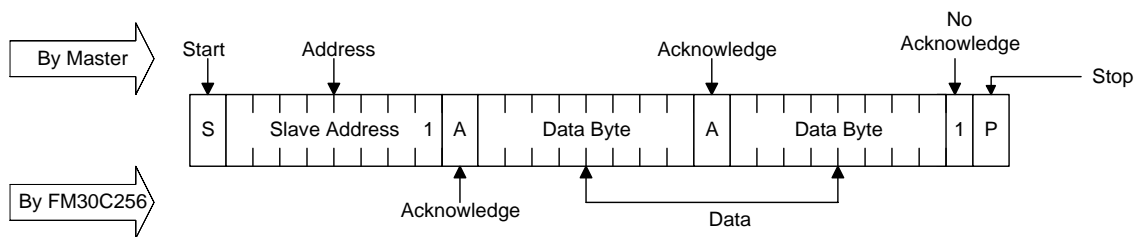

**Figure 9. Sequential Memory Read**

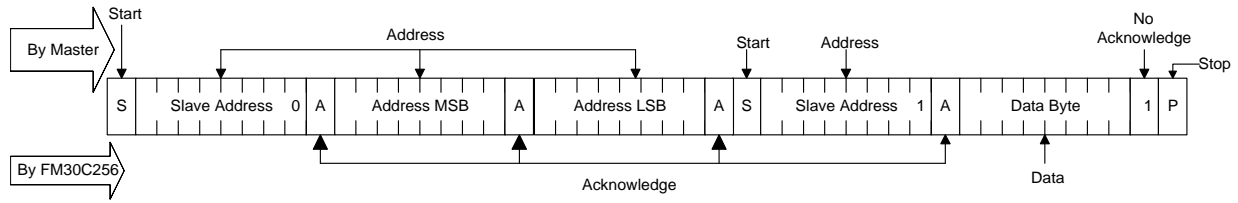

Figure 10. Selective (Random) Memory Read

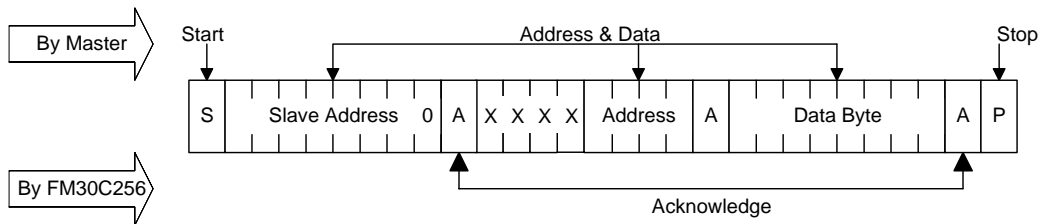

Figure 11. Byte RTC Write

## Electrical Specifications

### Absolute Maximum Ratings

Symbol	Description	Ratings
$V_{DD}$	Power Supply Voltage with respect to $V_{SS}$	-1.0V to +7.0V
$V_{IN}$	Voltage on any signal pin with respect to $V_{SS}$	-1.0V to +7.0V and $V_{IN} < V_{DD} + 1.0V$ *
$T_{STG}$	Storage temperature	-55°C to +125°C
$T_{LEAD}$	Lead temperature (Soldering, 10 seconds)	300° C
$V_{ESD}$	Electrostatic Discharge Voltage - Human Body Model, All pins (JEDEC Std JESD22-A114-B) - Machine Model (JEDEC Std JESD22-A115-A) o X1/X2 pins o All other pins	2kV  50V 300V
	Package Moisture Sensitivity Level	MSL-1

\* Exception: The " $V_{IN} < V_{DD} + 1.0V$ " restriction does not apply to the SCL and SDA inputs.

Stresses above those listed under Absolute Maximum Ratings may cause permanent damage to the device. This is a stress rating only, and the functional operation of the device at these or any other conditions above those listed in the operational section of this specification is not implied. Exposure to absolute maximum ratings conditions for extended periods may affect device reliability.

### DC Operating Conditions ( $T_A = -40^\circ\text{C}$ to $+85^\circ\text{C}$ , $V_{DD} = 4.5\text{V}$ to $5.5\text{V}$ unless otherwise specified)

Symbol	Parameter	Min	Typ	Max	Units	Notes
$V_{DD}$	Main Power Supply	4.5	5.0	5.5	V	
$I_{DD}$	$V_{DD}$ Supply Current @ SCL = 100 kHz @ SCL = 400 kHz @ SCL = 1 MHz			300 650 1.35	$\mu\text{A}$ $\mu\text{A}$ mA	1
$I_{SB}$	Standby Current			150	$\mu\text{A}$	2
$V_{BAK}$	Clock Backup Voltage	2.5	3.0	3.5	V	
$I_{BAK}$	Clock Backup Current			1	$\mu\text{A}$	5
$V_{TP}$	$V_{DD}$ trip point voltage that activates /RST	4.2		4.5	V	6
$V_{RST}$	$V_{DD}$ min for Active /RST @ $I_{OL} = 80\ \mu\text{A}$ , $V_{OL} = 0.4\text{V}$	1.2		-	V	7
$I_{LI}$	Input Leakage Current			1	$\mu\text{A}$	3
$I_{LO}$	Output Leakage Current			1	$\mu\text{A}$	3
$V_{IL}$	Input Low Voltage	-0.3		$0.3 V_{DD}$	V	
$V_{IH}$	Input High Voltage	$0.7 V_{DD}$		$V_{DD} + 0.3$	V	
$V_{ILB}$	Input Low Voltage (TIN) for $V_{DD} < V_{BAK}$ , otherwise $V_{IL}$ applies	-0.3		0.5	V	4
$V_{IHB}$	Input High Voltage (TIN) for $V_{DD} < V_{BAK}$ , otherwise $V_{IH}$ applies	$V_{BAK} - 0.5$		$V_{BAK} + 0.3$	V	4
$V_{OL}$	Output Low Voltage (CAL, /RST, SDA) @ $I_{OL} = 3\ \text{mA}$			0.4	V	
$V_{OH}$	Output High Voltage (CAL) @ $I_{OH} = -2\ \text{mA}$	2.4			V	
$R_{IN}$	Address Input Resistance (A2-A0) for $V_{IN} = V_{IL}$ (max) for $V_{IN} = V_{IH}$ (min)	20 1			K $\Omega$ M $\Omega$	8
$R_{TIN}$	TIN Input Resistance (Tamper Flag = 0)	5		30	K $\Omega$	8
$V_{HYS}$	Input Hysteresis (SCL, SDA)	$0.05 V_{DD}$			V	4

### Notes

- SCL toggling between  $V_{DD} - 0.3\text{V}$  and  $V_{SS}$ , other inputs  $V_{SS}$  or  $V_{DD} - 0.3\text{V}$ .
- SCL = SDA =  $V_{DD}$ . All inputs at  $V_{SS}$  or  $V_{DD}$ . Stop command issued.
- $V_{IN}$  or  $V_{OUT} = V_{SS}$  to  $V_{DD}$ . Does not apply to pins with internal pull down resistors.
- This parameter is characterized but not tested.

5.  $V_{BAK} = 3.0V$ ,  $V_{DD} < V_{BAK}$ , and  $TIN < V_{ILB}$  or  $TIN > V_{IHB}$ ; oscillator running.
6.  $/RST$  is asserted active when  $V_{DD} < V_{TP}$ .
7. The minimum  $V_{DD}$  to guarantee the level of  $/RST$  remains a valid  $V_{OL}$  level.
8. Resistance to  $V_{SS}$ .

**AC Parameters** ( $T_A = -40^\circ C$  to  $+85^\circ C$ ,  $V_{DD} = 4.5V$  to  $5.5V$ ,  $C_L = 100$  pF unless otherwise specified)

Symbol	Parameter	Min	Max	Min	Max	Min	Max	Units	Notes
$f_{SCL}$	SCL Clock Frequency	0	100	0	400	0	1000	kHz	
$t_{LOW}$	Clock Low Period	4.7		1.3		0.6		$\mu s$	
$t_{HIGH}$	Clock High Period	4.0		0.6		0.4		$\mu s$	
$t_{AA}$	SCL Low to SDA Data Out Valid		3		0.9		0.55	$\mu s$	
$t_{BUF}$	Bus Free Before New Transmission	4.7		1.3		0.5		$\mu s$	
$t_{HD:STA}$	Start Condition Hold Time	4.0		0.6		0.25		$\mu s$	
$t_{SU:STA}$	Start Condition Setup for Repeated Start	4.7		0.6		0.25		$\mu s$	
$t_{HD:DAT}$	Data In Hold	0		0		0		ns	
$t_{SU:DAT}$	Data In Setup	250		100		100		ns	
$t_R$	Input Rise Time		1000		300		300	ns	1
$t_F$	Input Fall Time		300		300		100	ns	1
$t_{SU:STO}$	Stop Condition Setup	4.0		0.6		0.25		$\mu s$	
$t_{DH}$	Data Output Hold (from SCL @ VIL)	0		0		0		ns	
$t_{SP}$	Noise Suppression Time Constant on SCL, SDA		50		50		50	ns	

**Notes:** All SCL specifications as well as start and stop conditions apply to both read and write operations.

- 1 This parameter is periodically sampled and not 100% tested.

**Power Cycle Timing** ( $T_A = -40^\circ C$  to  $+85^\circ C$ )

Symbol	Parameter	Min	Typ	Max	Units	Notes
$t_{RPU}$	Reset active after $V_{DD} > V_{TP}$	100	-	200	ms	
$t_{RNR}$	$V_{DD} < V_{TP}$ noise immunity	10	-	25	$\mu s$	1
$t_R$	Rise time of $V_{DD}$ from $V_{BAK}$ to $V_{TP}$	100	-		$\mu s$	1,2
$t_F$	Fall time of $V_{DD}$ from $V_{TP}$ to $V_{BAK}$	100	-		$\mu s$	1,2

**Notes**

- 1 This parameter is periodically sampled and not 100% tested.
- 2 Slew rate for proper transition between the battery-backed and normal operation.

**Data Retention** ( $V_{DD} = 4.5V$  to  $5.5V$  unless otherwise specified)

Parameter	Min	Units	Notes
Data Retention	10	Years	1

**Notes**

1. The relationship between retention, temperature, and the associated reliability level is characterized separately.

**Capacitance** ( $T_A = 25^\circ C$ ,  $f = 1.0$  MHz,  $V_{DD} = 5V$ )

Symbol	Parameter	Max	Units	Notes
$C_{IO}$	Input/output capacitance (SDA)	8	pF	1
$C_I$	Input capacitance	6	pF	1
$C_{XTAL}$	X1, X2 Crystal pin capacitance	12	pF	1, 2

**Notes**

- 1 This parameter is periodically sampled and not 100% tested.
- 2 The crystal attached to the X1/X2 pins must be rated as 6pF.



**AC Test Conditions**

Input Pulse Levels	0.1 V <sub>DD</sub> to 0.9 V <sub>DD</sub>
Input rise and fall times	10 ns
Input and output timing levels	0.5 V <sub>DD</sub>

**Equivalent AC Load Circuit**

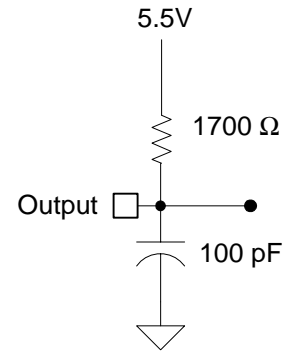

**Diagram Notes**

All start and stop timing parameters apply to both read and write cycles. Clock specifications are identical for read and write cycles. Write timing parameters apply to slave address, word address, and write data bits. Functional relationships are illustrated in the relevant data sheet sections. These diagrams illustrate the timing parameters only.

**Read Bus Timing**

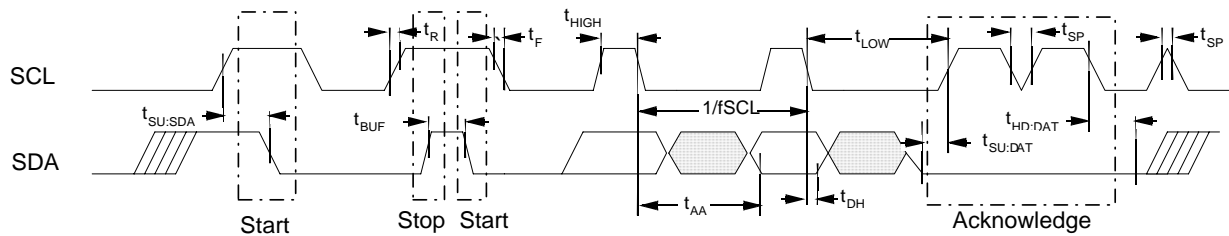

**Write Bus Timing**

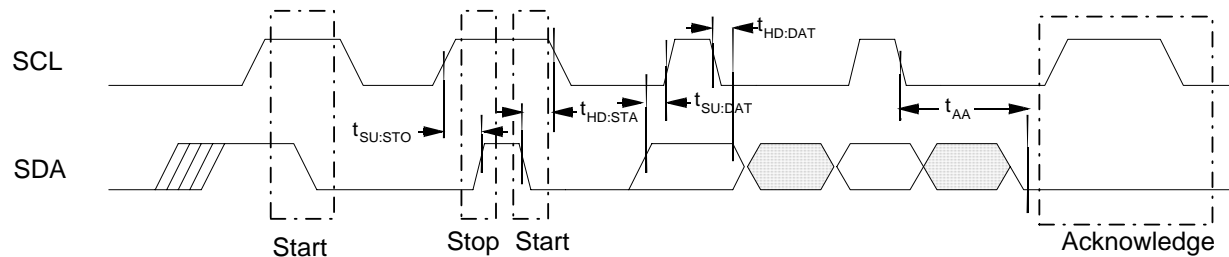

**/RST Timing**

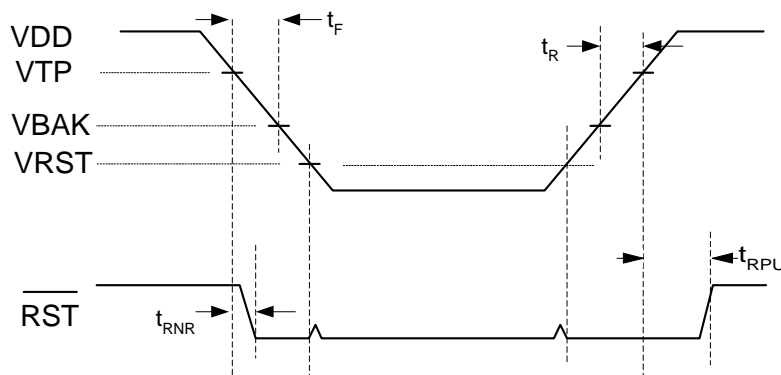

## 20-pin SOIC (JEDEC Standard MS-013 Variation AC)

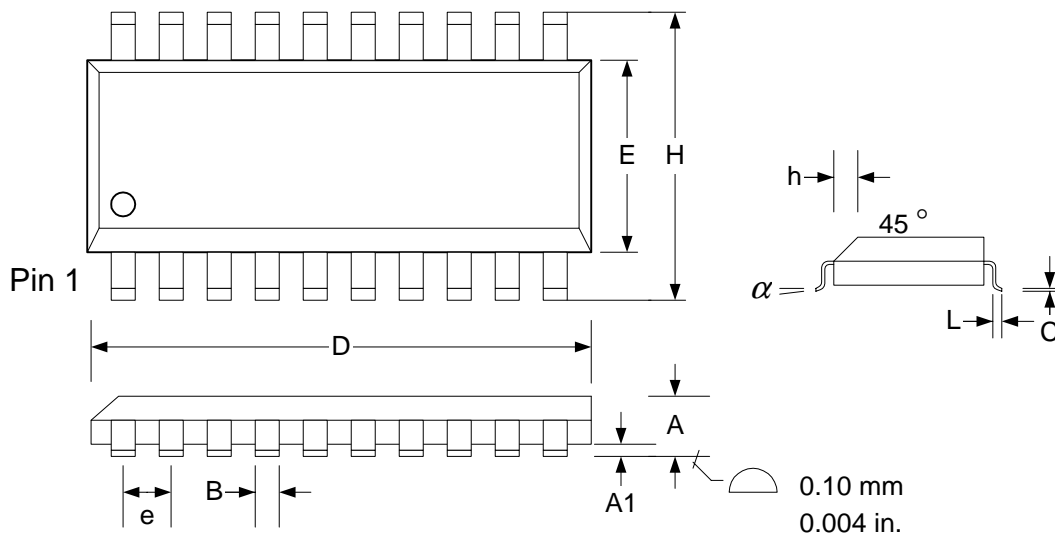

Controlling dimensions in millimeters.  
 Conversions to inches are not necessarily exact.

Symbol	Dim	Min	Nom.	Max
A	mm in.	2.35 0.093		2.65 0.104
A1	mm in.	0.10 0.004		0.30 0.012
B	mm in.	0.33 0.013		0.51 0.020
C	mm in.	0.23 0.009		0.32 0.013
D	mm in.	12.60 0.496		13.00 0.512
E	mm in.	7.40 0.291	7.50 0.295	7.60 0.299
e	mm in.		1.27 BSC 0.050 BSC	
H	mm in.	10.00 0.393		10.65 0.419
L	mm in.	0.40 0.016		1.27 0.05
alpha		0°		8°

**Revision History**

<b>Revision</b>	<b>Date</b>	<b>Summary</b>
0.1	5/10/01	Initial Release
0.2	9/17/01	Updated package & pinout. Changed Idd and Capacitance specifications. CAL pin changed from open drain to push/pull. CAL pin drives low when CAL bit is reset. TIN pin powered by VBAK, added DC specs for TIN. Timestamp feature added to Tamper Detect. Changed test load to 1700 ohms to reflect 3mA $V_{OL}$ test condition.
2.0	2/18/02	Changed to production status. Updated package drawing.
2.0A	4/17/02	Increased storage temperature range. Changed $V_{TP}$ (max) and $I_{OL}$ condition.
2.1	12/16/02	Modified block diagram and pin description to clarify crystal pins X1, X2.
2.2	10/20/03	Reduced input and output leakage limits. Added TIN input resistance spec. Clarified $V_{ILB}$ , $V_{IHB}$ , $R_{IN}$ , and $V_{HYS}$ conditions. Added color to block diagrams.
2.3	1/10/06	Added ESD and package MSL ratings to Abs Max Ratings table.