

# REALTEK

***NOT FOR PUBLIC RELEASE***

**RTL8111E-VL-CG**

## **INTEGRATED GIGABIT ETHERNET CONTROLLER FOR PCI EXPRESS APPLICATIONS**

### **DATASHEET**

**(CONFIDENTIAL: Development Partners Only)**

**Rev. 1.1**

**07 October 2010**

**Track ID: JATR-2265-11**



**Realtek Semiconductor Corp.**

No. 2, Innovation Road II, Hsinchu Science Park, Hsinchu 300, Taiwan

Tel.: +886-3-578-0211. Fax: +886-3-577-6047

[www.realtek.com](http://www.realtek.com)

**COPYRIGHT**

©2010 Realtek Semiconductor Corp. All rights reserved. No part of this document may be reproduced, transmitted, transcribed, stored in a retrieval system, or translated into any language in any form or by any means without the written permission of Realtek Semiconductor Corp.

**DISCLAIMER**

Realtek provides this document “as is”, without warranty of any kind. Realtek may make improvements and/or changes in this document or in the product described in this document at any time. This document could include technical inaccuracies or typographical errors.

**TRADEMARKS**

Realtek is a trademark of Realtek Semiconductor Corporation. Other names mentioned in this document are trademarks/registered trademarks of their respective owners.

**LICENSE**

This product is covered by one or more of the following patents: US5,307,459, US5,434,872, US5,732,094, US6,570,884, US6,115,776, and US6,327,625.

**USING THIS DOCUMENT**

This document is intended for the software engineer’s reference and provides detailed programming information.

Though every effort has been made to ensure that this document is current and accurate, more information may have become available subsequent to the production of this guide.

**REVISION HISTORY**

Revision	Release Date	Summary
1.0	2010/06/23	First release.
1.1	2010/10/07	Revised section 6.2.6 Customizable LED Configuration, page 12. Revised Table 18 Absolute Maximum Ratings, page 21. Revised Table 19 Recommended Operating Conditions, page 21.

## Table of Contents

<b>1. GENERAL DESCRIPTION</b> .....	<b>1</b>
<b>2. FEATURES</b> .....	<b>3</b>
<b>3. SYSTEM APPLICATIONS</b> .....	<b>3</b>
<b>4. PIN ASSIGNMENTS</b> .....	<b>4</b>
4.1. PACKAGE IDENTIFICATION.....	4
<b>5. PIN DESCRIPTIONS</b> .....	<b>5</b>
5.1. POWER MANAGEMENT/ISOLATION .....	5
5.2. PCI EXPRESS INTERFACE .....	5
5.3. TRANSCEIVER INTERFACE.....	6
5.4. CLOCK .....	6
5.5. REGULATOR AND REFERENCE.....	6
5.6. EEPROM .....	7
5.7. LEDs .....	7
5.8. SMBUS .....	7
5.9. POWER AND GROUND .....	8
5.10. GPO PIN .....	8
<b>6. FUNCTIONAL DESCRIPTION</b> .....	<b>9</b>
6.1. PCI EXPRESS BUS INTERFACE.....	9
6.1.1. PCI Express Transmitter .....	9
6.1.2. PCI Express Receiver.....	9
6.2. LED FUNCTIONS.....	9
6.2.1. Link Monitor.....	9
6.2.2. RX LED .....	10
6.2.3. TX LED.....	10
6.2.4. TX/RX LED.....	11
6.2.5. LINK/ACT LED .....	11
6.2.6. Customizable LED Configuration .....	12
6.3. PHY TRANSCEIVER .....	14
6.3.1. PHY Transmitter.....	14
6.3.2. PHY Receiver .....	14
6.4. NEXT PAGE .....	15
6.5. EEPROM INTERFACE.....	15
6.6. POWER MANAGEMENT.....	16
6.7. VITAL PRODUCT DATA (VPD).....	18
6.8. RECEIVE-SIDE SCALING (RSS) .....	19
6.8.1. Receive-Side Scaling (RSS) Initialization.....	19
6.8.2. Protocol Offload.....	20
6.8.3. RSS Operation .....	20
6.9. ENERGY EFFICIENT ETHERNET (EEE).....	20
<b>7. SWITCHING REGULATOR</b> .....	<b>20</b>
<b>8. CHARACTERISTICS</b> .....	<b>21</b>
8.1. ABSOLUTE MAXIMUM RATINGS .....	21
8.2. RECOMMENDED OPERATING CONDITIONS .....	21
8.3. CRYSTAL REQUIREMENTS.....	22
8.4. OSCILLATOR REQUIREMENTS .....	22
8.5. ENVIRONMENTAL CHARACTERISTICS .....	23
8.6. DC CHARACTERISTICS.....	23

---

8.7.	AC CHARACTERISTICS.....	24
8.7.1.	<i>Serial EEPROM Interface Timing</i> .....	24
8.8.	PCI EXPRESS BUS PARAMETERS.....	25
8.8.1.	<i>Differential Transmitter Parameters</i> .....	25
8.8.2.	<i>Differential Receiver Parameters</i> .....	26
8.8.3.	<i>REFCLK Parameters</i> .....	26
8.8.4.	<i>Auxiliary Signal Timing Parameters</i> .....	30
9.	MECHANICAL DIMENSIONS.....	31
10.	ORDERING INFORMATION.....	32

---

---

## List of Tables

---

TABLE 1. POWER MANAGEMENT/ISOLATION .....	5
TABLE 2. PCI EXPRESS INTERFACE .....	5
TABLE 3. TRANSCEIVER INTERFACE .....	6
TABLE 4. CLOCK .....	6
TABLE 5. REGULATOR AND REFERENCE .....	6
TABLE 6. EEPROM .....	7
TABLE 7. LEDs .....	7
TABLE 8. SMBUS .....	7
TABLE 9. POWER AND GROUND .....	8
TABLE 10. GPO PIN .....	8
TABLE 11. LED SELECT (IO REGISTER OFFSET 18H~19H) .....	12
TABLE 12. CUSTOMIZED LEDs .....	12
TABLE 13. FIXED LED MODE .....	12
TABLE 14. FEATURE CONTROL TABLE-1 .....	13
TABLE 15. FEATURE CONTROL TABLE-2 .....	13
TABLE 16. OPTION 1 & OPTION 2 LED TABLE .....	13
TABLE 17. EEPROM INTERFACE .....	15
TABLE 18. ABSOLUTE MAXIMUM RATINGS .....	21
TABLE 19. RECOMMENDED OPERATING CONDITIONS .....	21
TABLE 20. CRYSTAL REQUIREMENTS .....	22
TABLE 21. OSCILLATOR REQUIREMENTS .....	22
TABLE 22. ENVIRONMENTAL CHARACTERISTICS .....	23
TABLE 23. DC CHARACTERISTICS .....	23
TABLE 24. EEPROM ACCESS TIMING PARAMETERS .....	24
TABLE 25. DIFFERENTIAL TRANSMITTER PARAMETERS .....	25
TABLE 26. DIFFERENTIAL RECEIVER PARAMETERS .....	26
TABLE 27. REFCLK PARAMETERS .....	26
TABLE 28. AUXILIARY SIGNAL TIMING PARAMETERS .....	30
TABLE 29. ORDERING INFORMATION .....	32

---

## List of Figures

---

FIGURE 1. PIN ASSIGNMENTS .....	4
FIGURE 2. RX LED .....	10
FIGURE 3. TX LED .....	10
FIGURE 4. TX/RX LED .....	11
FIGURE 5. LINK/ACT LED .....	11
FIGURE 6. SERIAL EEPROM INTERFACE TIMING .....	24
FIGURE 7. SINGLE-ENDED MEASUREMENT POINTS FOR ABSOLUTE CROSS POINT AND SWING .....	28
FIGURE 8. SINGLE-ENDED MEASUREMENT POINTS FOR DELTA CROSS POINT .....	28
FIGURE 9. SINGLE-ENDED MEASUREMENT POINTS FOR RISE AND FALL TIME MATCHING .....	28
FIGURE 10. DIFFERENTIAL MEASUREMENT POINTS FOR DUTY CYCLE AND PERIOD .....	29
FIGURE 11. DIFFERENTIAL MEASUREMENT POINTS FOR RISE AND FALL TIME .....	29
FIGURE 12. DIFFERENTIAL MEASUREMENT POINTS FOR RINGBACK .....	29
FIGURE 13. REFERENCE CLOCK SYSTEM MEASUREMENT POINT AND LOADING .....	30
FIGURE 14. AUXILIARY SIGNAL TIMING .....	30

---

## 1. General Description

The Realtek RTL8111E-VL-CG Gigabit Ethernet controller combines a triple-speed IEEE 802.3 compliant Media Access Controller (MAC) with a triple-speed Ethernet transceiver, PCI Express bus controller, and embedded memory. With state-of-the-art DSP technology and mixed-mode signal technology, the RTL8111E offers high-speed transmission over CAT 5 UTP cable or CAT 3 UTP (10Mbps only) cable. Functions such as Crossover Detection and Auto-Correction, polarity correction, adaptive equalization, cross-talk cancellation, echo cancellation, timing recovery, and error correction are implemented to provide robust transmission and reception capability at high speeds.

The RTL8111E supports the PCI Express 1.1 bus interface for host communications with power management, and is compliant with the IEEE 802.3u specification for 10/100Mbps Ethernet and the IEEE 802.3ab specification for 1000Mbps Ethernet. It also supports an auxiliary power auto-detect function, and will auto-configure related bits of the PCI power management registers in PCI configuration space. The RTL8111E features embedded One-Time-Programmable (OTP) memory to replace the external EEPROM (93C46/93C56/93C66).

Advanced Configuration Power management Interface (ACPI)—power management for modern operating systems that are capable of Operating System-directed Power Management (OSPM)—is supported to achieve the most efficient power management possible. PCI MSI (Message Signaled Interrupt) and MSI-X are also supported.

In addition to the ACPI feature, remote wake-up (including AMD Magic Packet and Microsoft Wake-up frame) is supported in both ACPI and APM (Advanced Power Management) environments. To support WOL from a deep power down state (e.g., D3cold, i.e., main power is off and only auxiliary exists), the auxiliary power source must be able to provide the needed power for the RTL8111E.

The RTL8111E is fully compliant with Microsoft NDIS5, NDIS6 (IPv4, IPv6, TCP, UDP) Checksum and Segmentation Task-offload (Large send and Giant send) features, and supports IEEE 802 IP Layer 2 priority encoding and IEEE 802.1Q Virtual bridged Local Area Network (VLAN). The above features contribute to lowering CPU utilization, especially benefiting performance when in operation on a network server.

The RTL8111E supports Receive Side Scaling (RSS) to hash incoming TCP connections and load-balance received data processing across multiple CPUs. RSS improves the number of transactions per second and number of connections per second, for increased network throughput.

The RTL8111E supports Protocol offload. It offloads some of the most common protocols to NIC hardware in order to prevent spurious wake up and further reduce power consumption. The RTL8111E can offload ARP (IPv4) and NS (IPv6) protocols while in the D3 power saving state.

The RTL8111E supports IEEE 802.3az Draft 3.0, also known as Energy Efficient Ethernet (EEE). IEEE 802.3az operates with the IEEE 802.3 Media Access Control (MAC) Sublayer to support operation in Low Power Idle mode. When the Ethernet network is in low link utilization, EEE allows systems on both sides of the link to save power.

The device also features inter-connect PCI Express technology. PCI Express is a high-bandwidth, low-pin-count, serial, interconnect technology that offers significant improvements in performance over conventional PCI and also maintains software compatibility with existing PCI infrastructure.

The RTL8111E is suitable for multiple market segments and emerging applications, such as desktop, mobile, workstation, server, communications platforms, and embedded applications.

## 2. Features

- Integrated 10/100/1000 transceiver
- Auto-Negotiation with Next Page capability
- Supports PCI Express 1.1
- Supports pair swap/polarity/skew correction
- Crossover Detection & Auto-Correction
- Wake-on-LAN and remote wake-up support
- Microsoft NDIS5, NDIS6 Checksum Offload (IPv4, IPv6, TCP, UDP) and Segmentation Task-offload (Large send v1 and Large send v2) support
- Supports Full Duplex flow control (IEEE 802.3x)
- Supports jumbo frame to 9K bytes
- Fully compliant with IEEE 802.3, IEEE 802.3u, IEEE 802.3ab
- Supports IEEE 802.1P Layer 2 Priority Encoding
- Supports IEEE 802.1Q VLAN tagging
- Supports IEEE 802.3az Draft 3.0 (EEE)
- Embedded OTP memory can replace the external EEPROM
- Serial EEPROM
- Transmit/Receive on-chip buffer support
- Supports power down/link down power saving
- Built-in switching regulator
- Supports PCI MSI (Message Signaled Interrupt) and MSI-X
- Supports quad core Receive-Side Scaling (RSS)
- Supports Protocol Offload (ARP & NS)
- Supports Customized LEDs
- Supports 1-Lane 2.5Gbps PCI Express Bus
- Supports hardware ECC (Error Correction Code) function
- Supports hardware CRC (Cyclic Redundancy Check) function
- 48-pin QFN ‘Green’ package

## 3. System Applications

- PCI Express Gigabit Ethernet on Motherboard, Notebook, or Embedded systems



## 4. Pin Assignments

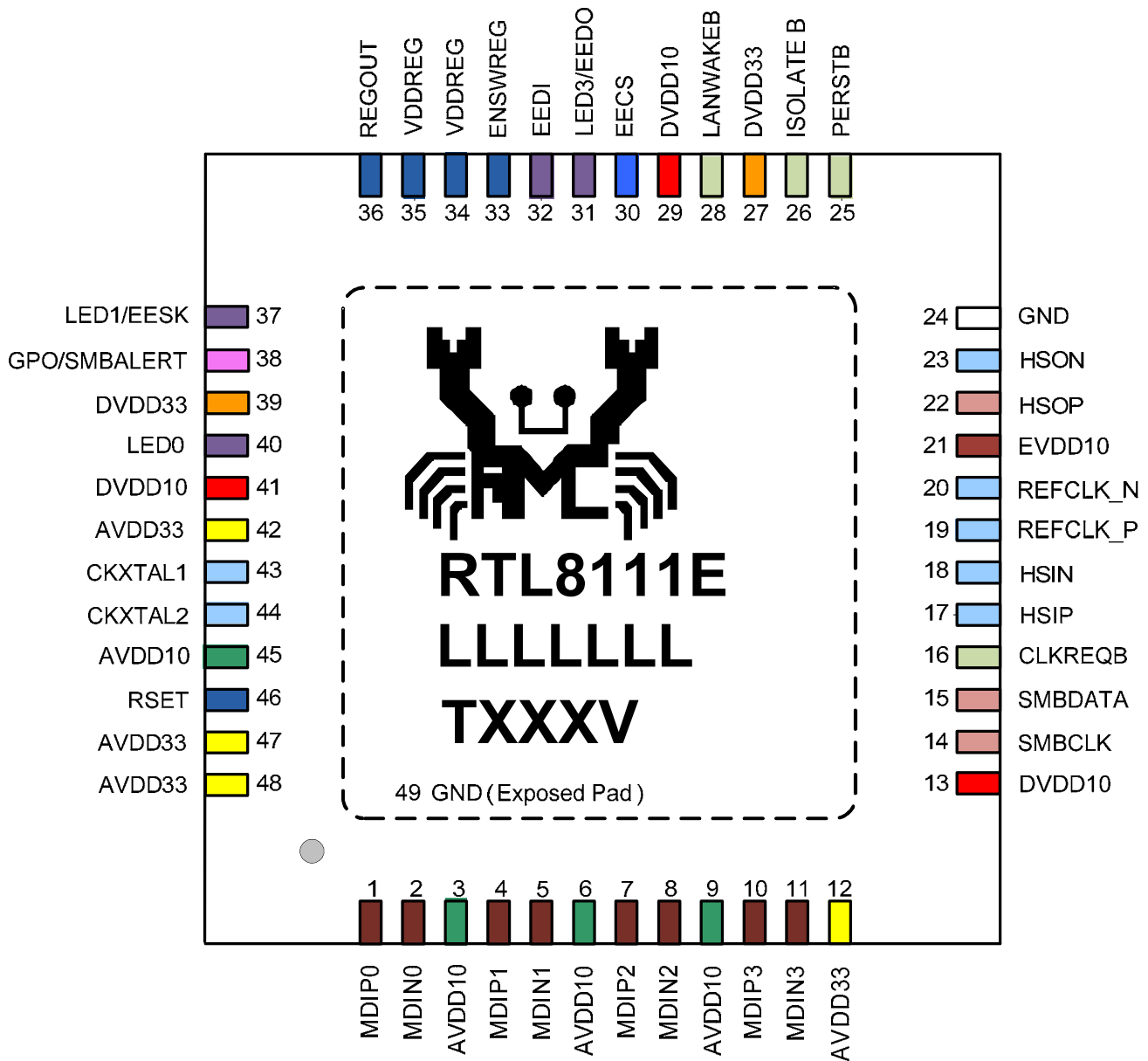


Figure 1. Pin Assignments

### 4.1. Package Identification

Green package is indicated by a ‘G’ in the location marked ‘T’ in Figure 1. The version is shown in the location marked ‘V’.

## 5. Pin Descriptions

The signal type codes below are used in the following tables:

I: Input	S/T/S: Sustained Tri-State
O: Output	O/D: Open Drain
T/S: Tri-State bi-directional input/output pin	P: Power

### 5.1. Power Management/Isolation

**Table 1. Power Management/Isolation**

Symbol	Type	Pin No	Description
LANWAKEB	O/D	28	Power Management Event: Open drain, active low. Used to reactivate the PCI Express slot's main power rails and reference clocks. Refer to the reference schematic for strapping pin information. All strapping pins are power-on-latch pins.
ISOLATEB	I	26	Isolate Pin: Active low. Used to isolate the RTL8111E from the PCI Express bus. The RTL8111E will not drive its PCI Express outputs (excluding LANWAKEB) and will not sample its PCI Express input as long as the Isolate pin is asserted.

### 5.2. PCI Express Interface

**Table 2. PCI Express Interface**

Symbol	Type	Pin No	Description
REFCLK_P	I	19	PCI Express Differential Reference Clock Source: 100MHz $\pm$ 300ppm.
REFCLK_N	I	20	
HSOP	O	22	PCI Express Transmit Differential Pair.
HSON	O	23	
HSIP	I	17	PCI Express Receive Differential Pair.
HSIN	I	18	
PERSTB	I	25	PCI Express Reset Signal: Active low. When the PERSTB is asserted at power-on state, the RTL8111E returns to a pre-defined reset state and is ready for initialization and configuration after the de-assertion of the PERSTB.
CLKREQB	O/D	16	Reference Clock Request Signal. This signal is used by the RTL8111E to request starting of the PCI Express reference clock. Refer to the reference schematic for strapping pin information. All strapping pins are power-on-latch pins.

### 5.3. Transceiver Interface

**Table 3. Transceiver Interface**

Symbol	Type	Pin No	Description
MDIP0	IO	1	In MDI mode, this is the first pair in 1000Base-T, i.e., the BI_DA+/- pair, and is the transmit pair in 10Base-T and 100Base-TX.
MDIN0	IO	2	
MDIP1	IO	4	In MDI mode, this is the second pair in 1000Base-T, i.e., the BI_DB+/- pair, and is the receive pair in 10Base-T and 100Base-TX.
MDIN1	IO	5	
MDIP2	IO	7	In MDI mode, this is the third pair in 1000Base-T, i.e., the BI_DC+/- pair.
MDIN2	IO	8	
MDIP3	IO	10	In MDI mode, this is the fourth pair in 1000Base-T, i.e., the BI_DD+/- pair.
MDIN3	IO	11	

### 5.4. Clock

**Table 4. Clock**

Symbol	Type	Pin No	Description
CKXTAL1	I	43	Input of 25MHz Clock Reference.
CKXTAL2	IO	44	Input of External Clock Source. Output of 25MHz Clock Reference.

### 5.5. Regulator and Reference

**Table 5. Regulator and Reference**

Symbol	Type	Pin No	Description
REGOUT	O	36	Switching Regulator 1.0V Output.
ENSWREG	I	33	3.3V: Enable switching regulator. 0V: Disable switching regulator.
VDDREG	P	34, 35	Digital 3.3V Power Supply for Switching Regulator.
RSET	I	46	Reference. External resistor reference.

Note: See section 7, page 20 for switching regulator.

## 5.6. EEPROM

**Table 6. EEPROM**

Symbol	Type	Pin No	Description
EESK	O	37	Serial Data Clock.
EEDI	O/I	32	EEDI: Output to serial data input pin of EEPROM. Refer to the reference schematic for strapping pin information. All strapping pins are power-on-latch pins.
EEDO	I	31	Input from Serial Data Output Pin of EEPROM.
EECS	O	30	EECS: EEPROM Chip Select. Refer to the reference schematic for strapping pin information. All strapping pins are power-on-latch pins.

## 5.7. LEDs

**Table 7. LEDs**

Symbol	Type	Pin No	Description
LED0	O	40	See section 6.2.6 Customizable LED Configuration, page 12 for details.
LED1	O	37	
LED3	O	31	

Note 1: During power down mode, the LED signals are logic high.

Note 2: LEDSI-0's initial value comes from the EEPROM. If there is no EEPROM, the default value of the (LEDS1, LEDS0)=(1, 1).

### When implementing dual color LEDs and EEPROM at the same time:

Pin31 and Pin37 of the RTL8111E are shared pins. Follow the RTLRTL8111E reference design (version 1.00 or later) to select these 2 pins for a dual-color LED circuit. Otherwise, the RTLRTL8111E EEPROM may not function.

## 5.8. SMBus

**Table 8. SMBus**

Symbol	Type	Pin No	Description
SMBCLK	O/D	14	SMBus Clock. Refer to the reference schematic for strapping pin information. All strapping pins are power-on-latch pins.
SMBDATA	O/D	15	SMBus Data. Refer to the reference schematic for strapping pin information. All strapping pins are power-on-latch pins.
SMBALERT	O/D	38	SMBus Alert. Refer to the reference schematic for strapping pin information. All strapping pins are power-on-latch pins.

## 5.9. Power and Ground

**Table 9. Power and Ground**

Symbol	Type	Pin No	Description
DVDD33	P	27, 39	Digital 3.3V Power Supply.
DVDD10	P	13, 29, 41	Digital 1.0V Power Supply.
AVDD10	P	3, 6, 9, 45	Analog 1.0V Power Supply.
EVDD10	P	21	Analog 1.0V Power Supply.
AVDD33	P	12, 42, 47, 48	Analog 3.3V Power Supply.
GND	P	24	Ground.
GND	P	49	Ground (Exposed Pad).

*Note: Refer to the latest schematic circuit for correct configuration.*

## 5.10. GPO Pin

**Table 10. GPO Pin**

Symbol	Type	Pin No	Description
GPO	O/D	38	General Purpose Output Pin. This pin reflects the link up or link down state. High: Link up Low: Link down Refer to the reference schematic for strapping pin information. All strapping pins are power-on-latch pins.

## **6. Functional Description**

### ***6.1. PCI Express Bus Interface***

The RTL8111E complies with PCI Express Base Specification Revision 1.1, and runs at a 2.5GHz signaling rate with X1 link width, i.e., one transmit and one receive differential pair. The RTL8111E supports four types of PCI Express messages: interrupt messages, error messages, power management messages, and hot-plug messages. To ease PCB layout constraints, PCI Express lane polarity reversal and link reversal are also supported.

#### **6.1.1. PCI Express Transmitter**

The RTL8111E's PCI Express block receives digital data from the Ethernet interface and performs data scrambling with Linear Feedback Shift Register (LFSR) and 8B/10B coding technology into 10-bit code groups. Data scrambling is used to reduce the possibility of electrical resonance on the link, and 8B/10B coding technology is used to benefit embedded clocking, error detection, and DC balance by adding an overhead to the system through the addition of 2 extra bits. The data code groups are passed through its serializer for packet framing. The generated 2.5Gbps serial data is transmitted onto the PCB trace to its upstream device via a differential driver.

#### **6.1.2. PCI Express Receiver**

The RTL8111E's PCI Express block receives 2.5Gbps serial data from its upstream device to generate parallel data. The receiver's PLL circuits are re-synchronized to maintain bit and symbol lock. Through 8B/10B decoding technology and data de-scrambling, the original digital data is recovered and passed to the RTL8111E's internal Ethernet MAC to be transmitted onto the Ethernet media.

### ***6.2. LED Functions***

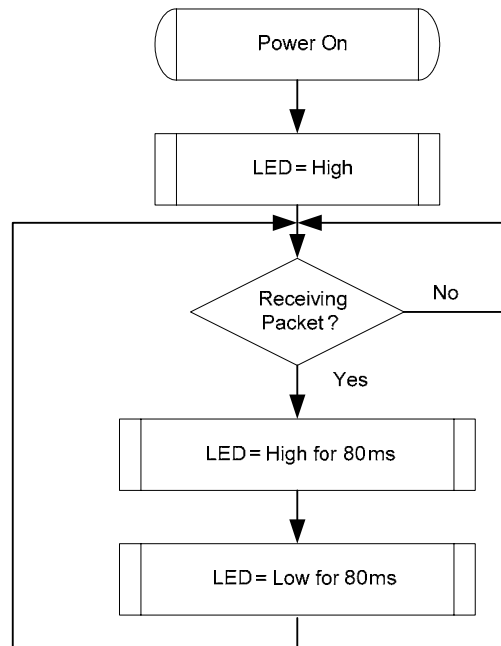
The RTL8111E supports three LED signals in four configurable operation modes. The following sections describe the various LED actions.

#### **6.2.1. Link Monitor**

The Link Monitor senses link integrity, such as LINK10, LINK100, LINK1000, LINK10/ACT, LINK100/ACT, or LINK1000/ACT. Whenever link status is established, the specific link LED pin is driven low. Once a cable is disconnected, the link LED pin is driven high, indicating that no network connection exists.

### 6.2.2. RX LED

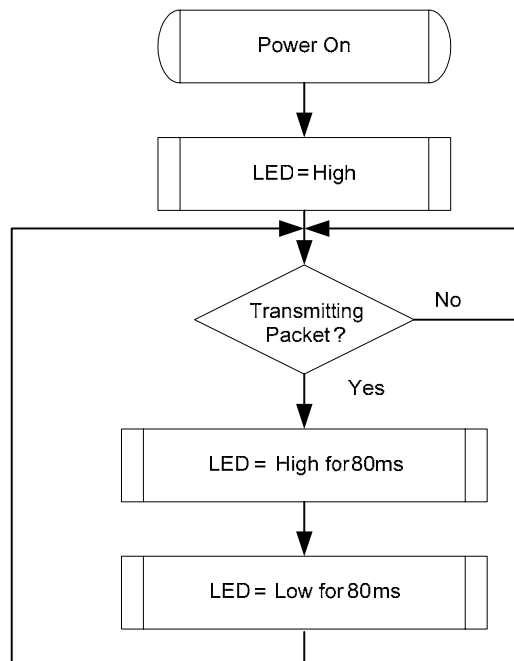
In 10/100/1000Mbps mode, blinking of the RX LED indicates that receive activity is occurring.



**Figure 2. RX LED**

### 6.2.3. TX LED

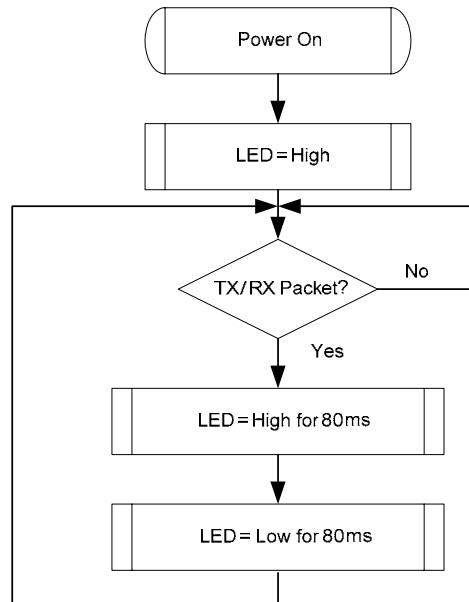
In 10/100/1000Mbps mode, blinking of the TX LED indicates that transmit activity is occurring.



**Figure 3. TX LED**

### 6.2.4. TX/RX LED

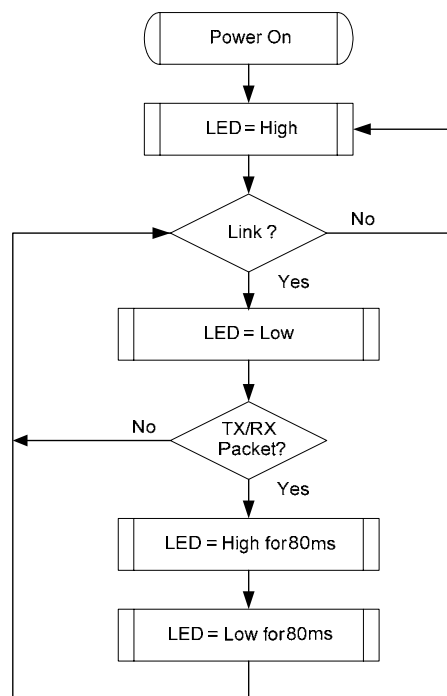
In 10/100/1000Mbps mode, blinking of the TX/RX LED indicates that both transmit and receive activity is occurring.



**Figure 4. TX/RX LED**

### 6.2.5. LINK/ACT LED

In 10/100/1000Mbps mode, blinking of the LINK/ACT LED indicates that the RTL8111E is linked and operating properly. When this LED is high for extended periods, it indicates that a link problem exists.



**Figure 5. LINK/ACT LED**



## 6.2.6. Customizable LED Configuration

The RTL8111E supports customizable LED operation modes via IO register offset 18h~19h. Table 11 describes the different LED actions.

**Table 11. LED Select (IO Register Offset 18h~19h)**

Bit	Symbol	RW	Description
15:12	LEDCntl	RW	LED Feature Control
11:8	LEDSEL3	RW	LED Select for PINLED3
7:4	LEDSEL1	RW	LED Select for PINLED1
3:0	LEDSEL0	RW	LED Select for PINLED0

When implementing customized LEDs:

Configure IO register offset 18h~19h to support your own LED signals. For example, if the value in the IO offset 0x18 is 0x0CA9h (0000110010101001b), the LED actions are:

- LED 0: On only in 10M mode, with blinking during TX/RX
- LED 1: On only in 100M mode, with blinking during TX/RX
- LED 3: On only in 1000M mode, with blinking during TX/RX

**Table 12. Customized LEDs**

Speed	LINK			ACT/Full
	Link 10M	Link 100M	Link 1000M	
LED 0	Bit 0	Bit 1	Bit 2	Bit 3
LED 1	Bit 4	Bit 5	Bit 6	Bit 7
LED 3	Bit 8	Bit 9	Bit 10	Bit 11
Feature Control	Bit 12	Bit 13	Bit 14	Bit 15

*Note: There are two special modes:*

*LED OFF Mode: Set all bits to 0. All LED pin output become floating (power saving).*

*Fixed LED Mode: Set Option 1 LED table Mode: LED0=LED1=LED2=1 or 2 (see Table 13).*

**Table 13. Fixed LED Mode**

Bit31~Bit0 Value	LED0	LED1	LED2
1XXX 0001 0001 0001	ACT	LINK	Full Duplex + Collision
1XXX 0010 0010 0010	Transmit	LINK	Receive

*Note: 'X' indicates 'irrelevant'.*

**Table 14. Feature Control Table-1**

Feature Control	Bit12	Bit13	Bit14	Bit15
0	LED0 Low Active	LED1 Low Active	LED2 Low Active	Option 1 LED Table Selected
1	LED0 High Active	LED1 High Active	LED2 High Active	Option 2 LED Table Selected

**Table 15. Feature Control Table-2**

LED Pin	ACT=0	ACT=1
LINK=0	Floating	All Speed ACT
LINK>0	Selected Speed LINK	Option 1: Selected Speed LINK+ Selected Speed ACT Option 2: Selected Speed LINK+ All Speed ACT

**Table 16. Option 1 & Option 2 LED Table**

Link Bit			Active Bit	Description		
10	100	1000		Link	Option 1 LED Activity	Option 2 LED Activity
0	0	0	0		LED Off	
0	0	0	1	-	Act <sup>10</sup> +Act <sup>100</sup> +Act <sup>1G</sup>	Act <sup>10</sup> +Act <sup>100</sup> +Act <sup>1G</sup>
0	0	1	0	Link <sup>1G</sup>	-	-
0	0	1	1	Link <sup>1G</sup>	Act <sup>1G</sup>	Act <sup>10</sup> +Act <sup>100</sup> +Act <sup>1G</sup>
0	1	0	0	Link <sup>100</sup>	-	-
0	1	0	1	Link <sup>100</sup>	Act <sup>100</sup>	Act <sup>10</sup> +Act <sup>100</sup> +Act <sup>1G</sup>
0	1	1	0	Link <sup>100</sup> +Link <sup>1G</sup>	-	-
0	1	1	1	Link <sup>100</sup> +Link <sup>1G</sup>	Act <sup>100</sup> +Act <sup>1G</sup>	Act <sup>10</sup> +Act <sup>100</sup> +Act <sup>1G</sup>
1	0	0	0	Link <sup>10</sup>	-	-
1	0	0	1	Link <sup>10</sup>	Act <sup>10</sup>	Act <sup>10</sup> +Act <sup>100</sup> +Act <sup>1G</sup>
1	0	1	0	Link <sup>10</sup> +Link <sup>1G</sup>	-	-
1	0	1	1	Link <sup>10</sup> +Link <sup>1G</sup>	Act <sup>10</sup> +Act <sup>1G</sup>	Act <sup>10</sup> +Act <sup>100</sup> +Act <sup>1G</sup>
1	1	0	0	Link <sup>10</sup> +Link <sup>100</sup>	-	-
1	1	0	1	Link <sup>10</sup> +Link <sup>100</sup>	Act <sup>10</sup> +Act <sup>100</sup>	Act <sup>10</sup> +Act <sup>100</sup> +Act <sup>1G</sup>
1	1	1	0	Link <sup>10</sup> +Link <sup>100</sup> +Link <sup>1G</sup>	-	-
1	1	1	1	Link <sup>10</sup> +Link <sup>100</sup> +Link <sup>1G</sup>	Act <sup>10</sup> +Act <sup>100</sup> +Act <sup>1G</sup>	Act <sup>10</sup> +Act <sup>100</sup> +Act <sup>1G</sup>

Note:

Act<sup>10</sup> = LED blinking when Ethernet packets transmitted/received at 10Mbps.

Act<sup>100</sup> = LED blinking when Ethernet packets transmitted/received at 100Mbps.

Act<sup>1G</sup> = LED blinking when Ethernet packets transmitted/received at 1000Mbps.

Link<sup>10</sup> = LED lit when Ethernet connection established at 10Mbps.

Link<sup>100</sup> = LED lit when Ethernet connection established at 100Mbps.

Link<sup>1G</sup> = LED lit when Ethernet connection established at 1000Mbps.

## **6.3. PHY Transceiver**

### **6.3.1. PHY Transmitter**

Based on state-of-the-art DSP technology and mixed-mode signal processing technology, the RTL8111E operates at 10/100/1000Mbps over standard CAT.5 UTP cable (100/1000Mbps), or CAT.3 UTP cable (10Mbps).

#### **GMII (1000Mbps) Mode**

The RTL8111E's PCS layer receives data bytes from the MAC through the GMII interface and performs the generation of continuous code-groups through 4D-PAM5 coding technology. These code groups are passed through a waveform-shaping filter to minimize EMI effects, and are transmitted onto the 4-pair CAT5 cable at 125MBaud/s through a D/A converter.

#### **MII (100Mbps) Mode**

The transmitted 4-bit nibbles (TXD[3:0]) from the MAC, clocked at 25MHz (TXC), are converted into 5B symbol code through 4B/5B coding technology, then through scrambling and serializing, are converted to 125MHz NRZ and NRZI signals. After that, the NRZI signals are passed to the MLT3 encoder, then to the D/A converter and transmitted onto the media.

#### **MII (10Mbps) Mode**

The transmitted 4-bit nibbles (TXD[3:0]) from the MAC, clocked at 2.5MHz (TXC), are serialized into 10Mbps serial data. The 10Mbps serial data is converted into a Manchester-encoded data stream and is transmitted onto the media by the D/A converter.

### **6.3.2. PHY Receiver**

#### **GMII (1000Mbps) Mode**

Input signals from the media pass through the sophisticated on-chip hybrid circuit to separate the transmitted signal from the input signal for effective reduction of near-end echo. Afterwards, the received signal is processed with state-of-the-art technology, e.g., adaptive equalization, BLW (Baseline Wander) correction, cross-talk cancellation, echo cancellation, timing recovery, error correction, and 4D-PAM5 decoding. Then, the 8-bit-wide data is recovered and is sent to the GMII interface at a clock speed of 125MHz. The RX MAC retrieves the packet data from the receive MII/GMII interface and sends it to the RX Buffer Manager.

#### **MII (100Mbps) Mode**

The MLT3 signal is processed with an ADC, equalizer, BLW (Baseline Wander) correction, timing recovery, MLT3 and NRZI decoder, descrambler, 4B/5B decoder, and is then presented to the MII interface in 4-bit-wide nibbles at a clock speed of 25MHz.

#### **MII (10Mbps) Mode**

The received differential signal is converted into a Manchester-encoded stream first. Next, the stream is processed with a Manchester decoder and is de-serialized into 4-bit-wide nibbles. The 4-bit nibbles are presented to the MII interface at a clock speed of 2.5MHz.

## 6.4. Next Page

If 1000Base-T mode is advertised, three additional Next Pages are automatically exchanged between the two link partners. Users can set PHY Reg4.15 to 1 to manually exchange extra Next Pages via Reg7 and Reg8 as defined in IEEE 802.3ab.

## 6.5. EEPROM Interface

The RTL8111E requires the attachment of an external EEPROM. The 93C46/93C56/93C66 is a 1K-bit/2K-bit/4K-bit EEPROM. The EEPROM interface permits the RTL8111E to read from, and write data to, an external serial EEPROM device.

Values in the internal eFUSE memory or external EEPROM allow default fields in PCI configuration space and I/O space to be overridden following a power-on or software EEPROM auto-load command. The RTL8111E will auto-load values from the eFUSE or EEPROM. If the EEPROM is not present and eFUSE auto-load is bypassed, the RTL8111E initialization uses default values for the appropriate Configuration and Operational Registers. Software can read and write to the EEPROM using bit-bang accesses via the 9346CR Register, or using PCI VPD (Vital Product Data). The EEPROM interface consists of EESK, EECS, EEDO, and EEDI.

The correct EEPROM (i.e., 93C46/93C56/93C66) must be used in order to ensure proper LAN function.

**Table 17. EEPROM Interface**

EEPROM	Description
EECS	93C46/93C56/93C66 Chip Select.
EESK	EEPROM Serial Data Clock.
EEDI	Output to Serial Data Input Pin of EEPROM.
EEDO	Output Data Bus.

## 6.6. Power Management

The RTL8111E complies with ACPI (Rev 1.0, 1.0b, 2.0), PCI Power Management (Rev 1.1), PCI Express Active State Power Management (ASPM), and Network Device Class Power Management Reference Specification (V1.0a), such as to support an Operating System-directed Power Management (OSPM) environment.

The RTL8111E can monitor the network for a Wakeup Frame or a Magic Packet, and notify the system via a PCI Express Power Management Event (PME) Message, Beacon, or the LANWAKEB pin when such a packet or event occurs. Then the system can be restored to a normal state to process incoming jobs.

When the RTL8111E is in power down mode (D1~D3):

- The RX state machine is stopped. The RTL8111E monitors the network for wakeup events such as a Magic Packet and Wakeup Frame in order to wake up the system. When in power down mode, the RTL8111E will not reflect the status of any incoming packets in the ISR register and will not receive any packets into the RX on-chip buffer.
- The on-chip buffer status and packets that have already been received into the RX on-chip buffer before entering power down mode are held by the RTL8111E.
- Transmission is stopped. PCI Express transactions are stopped. The TX on-chip buffer is held.
- After being restored to D0 state, the RTL8111E transmits data that was not moved into the TX on-chip buffer during power down mode. Packets that were not transmitted completely last time are re-transmitted.

The D3<sub>cold</sub>\_support\_PME bit (bit15, PMC register) and the Aux\_I\_b2:0 bits (bit8:6, PMC register) in PCI configuration space depend on the existence of Aux power. If aux. power is absent, the above 4 bits are all 0 in binary.

Example:

If EEPROM D3c\_support\_PME = 1:

- If aux. power exists, then PMC in PCI config space is the same as EEPROM PMC (if EEPROM PMC = C3 FF, then PCI PMC = C3 FF)
- If aux. power is absent, then PMC in PCI config space is the same as EEPROM PMC except the above 4 bits are all 0's (if EEPROM PMC = C3 FF, then PCI PMC = 03 7E)

In the above case, if wakeup support is desired when main power is off, it is suggested that the EEPROM PMC be set to C3 FF (Realtek EEPROM default value).

If EEPROM D3c\_support\_PME = 0:

- If aux. power exists, then PMC in PCI config space is the same as EEPROM PMC (if EEPROM PMC = C3 7F, then PCI PMC = C3 7F)
- If aux. power is absent, then PMC in PCI config space is the same as EEPROM PMC except the above 4 bits are all 0's (if EEPROM PMC = C3 7F, then PCI PMC = 03 7E)

In the above case, if wakeup support is not desired when main power is off, it is suggested that the EEPROM PMC be set to 03 7E.

Magic Packet Wakeup occurs only when the following conditions are met:

- The destination address of the received Magic Packet is acceptable to the RTL8111E, e.g., a broadcast, multicast, or unicast packet addressed to the current RTL8111E.
- The received Magic Packet does not contain a CRC error.
- The Magic bit (CONFIG3#5) is set to 1, the PMEn bit (CONFIG1#0) is set to 1, and the corresponding wake-up method (message, beacon, or LANWAKEB) can be asserted in the current power state.
- The Magic Packet pattern matches, i.e., 6 \* FFh + MISC (can be none) + 16 \* DID (Destination ID) in any part of a valid Ethernet packet.

A Wakeup Frame event occurs only when the following conditions are met:

- The destination address of the received Wakeup Frame is acceptable to the RTL8111E, e.g., a broadcast, multicast, or unicast address to the current RTL8111E.
- The received Wakeup Frame does not contain a CRC error.
- The PMEn bit (CONFIG1#0) is set to 1.
- The 16-bit CRC\* of the received Wakeup Frame matches the 16-bit CRC of the sample Wakeup Frame pattern given by the local machine's OS. Or, the RTL8111E is configured to allow direct packet wakeup, e.g., a broadcast, multicast, or unicast network packet.

*Note: 16-bit CRC: The RTL8111E supports eight long-wakeup frames (covering 128 mask bytes from offset 0 to 127 of any incoming network packet).*

The corresponding wake-up method (message or LANWAKEB) is asserted only when the following conditions are met:

- The PMEn bit (bit0, CONFIG1) is set to 1.
- The PME\_En bit (bit8, PMCSR) in PCI Configuration Space is set to 1.
- The RTL8111E may assert the corresponding wake-up method (message or LANWAKEB) in the current power state or in isolation state, depending on the PME\_Support (bit15~11) setting of the PMC register in PCI Configuration Space.
- A Magic Packet, LinkUp, or Wakeup Frame has been received.
- Writing a 1 to the PME\_Status (bit15) of the PMCSR register in the PCI Configuration Space clears this bit and causes the RTL8111E to stop asserting the corresponding wake-up method (message or LANWAKEB) (if enabled).

When the RTL8111E is in power down mode, e.g., D1~D3, the IO, and MEM accesses to the RTL8111E are disabled. After a PERSTB assertion, the device's power state is restored to D0 automatically if the original power state was D3<sub>cold</sub>. There is almost no hardware delay at the device's power state transition. When in ACPI mode, the device does not support PME (Power Management Enable) from D0 (this is the Realtek default setting of the PMC register auto-loaded from EEPROM). The setting may be changed from the EEPROM, if required.

## **6.7. Vital Product Data (VPD)**

Bit 31 of the Vital Product Data (VPD) capability structure in the RTL8111E's PCI Configuration Space is used to issue VPD read/write commands and is also a flag used to indicate whether the transfer of data between the VPD data register and the 93C46/93C56/93C66 has completed or not.

### **Write VPD register: (write data to the 93C46/93C56/93C66):**

Set the flag bit to 1 at the same time the VPD address is written to write VPD data to EEPROM. When the flag bit is reset to 0 by the RTL8111E, the VPD data (4 bytes per VPD access) has been transferred from the VPD data register to EEPROM.

### **Read VPD register: (read data from the 93C46/93C56/93C66):**

Reset the flag bit to 0 at the same time the VPD address is written to retrieve VPD data from EEPROM. When the flag bit is set to 1 by the RTL8111E, the VPD data (4 bytes per VPD access) has been transferred from EEPROM to the VPD data register.

*Note1: Refer to the PCI 2.3 Specifications for further information.*

*Note2: The VPD address must be a DWORD-aligned address as defined in the PCI 2.3 Specifications. VPD data is always consecutive 4-byte data starting from the VPD address specified.*

*Note3: Realtek reserves offset 60h to 7Fh in EEPROM mainly for VPD data to be stored.*

*Note4: The VPD function of the RTL8111E is designed to be able to access the full range of the 93C46/93C56/93C66 EEPROM.*

## **6.8. Receive-Side Scaling (RSS)**

The RTL8111E complies with the Network Driver Interface Specification (NDIS) 6.0 Receive-Side Scaling (RSS) technology for the Microsoft Windows family of operating systems. RSS allows packet receive-processing from a network adapter to be balanced across the number of available computer processors, increasing performance on multi-CPU platforms.

### **6.8.1. Receive-Side Scaling (RSS) Initialization**

During RSS initialization, the Windows operating system will inform the RTL8111E that it should store the following parameters: hash function, hash type, hash bits, indirection table, BaseCPUNumber, and the secret hash key.

#### **Hash Function**

The default hash function is the Toeplitz hash function.

#### **Hash Type**

The hash types indicate which field of the packet needs to be hashed to get the hash result. There are several combinations of these fields, mainly, TCP/IPv4, IPv4, TCP/IPv6, IPv6, and IPv6 extension headers.

- TCP/IPv4 requires hash calculations over the IPv4 source address, the IPv4 destination address, the source TCP port and the destination TCP port.
- IPv4 requires hash calculations over the IPv4 source address and the IPv4 destination address.
- TCP/IPv6 requires hash calculations over the IPv6 source address, the IPv6 destination address, the source TCP port and the destination TCP port.
- IPv6 requires hash calculations over the IPv6 source address and the IPv6 destination address  
(*Note: The RTL8111E does not support the IPv6 extension header hash type in RSS.*)

#### **Hash Bits**

Hash bits are used to index the hash result into the indirection table

#### **Indirection Table**

The Indirection Table stores values that are added to the BaseCPUNumber to enable RSS interrupts to be restricted from some CPUs. The OS will update the Indirection Table to rebalance the load.

#### **BaseCPUNumber**

The lowest number CPU to use for RSS. BaseCPUNumber is added to the result of the indirection table lookup.

#### **Secret Hash Key**

The key used in the Toeplitz function. For different hash types, the key size is different.



### **6.8.2. Protocol Offload**

Protocol offload is a task offload supported by Microsoft Windows 7. It maintains a network presence for a sleeping higher power host. Protocol offload prevents spurious wake up and further reduces power consumption. It maintains connectivity while hosts are asleep, including receiving requests from other nodes on the network, ignoring packets, generating packets while in the sleep state (e.g., the Ethernet Controller will generate ARP responses if the same MAC and IPv4 address are provided in the configuration data), and intelligently waking up host systems.

### **6.8.3. RSS Operation**

After the parameters are set, the RTL8111E will start hash calculations on each incoming packet and forward each packet to its correct queue according to the hash result. If the incoming packet is not in the hash type, it will be forwarded to the primary queue. The hash result plus the BaseCPUNumber will be indexed into the indirection table to get the correct CPU number. The RTL8111E uses three methods to inform the system of incoming packets: inline interrupt, MSI, and MSIX. Periodically the OS will update the indirection table to rebalance the load across the CPUs.

## ***6.9. Energy Efficient Ethernet (EEE)***

The RTL8111E supports IEEE 802.3az Draft 3.2, also known as Energy Efficient Ethernet (EEE), at 10Mbps, 100Mbps, and 1000Mbps. It provides a protocol to coordinate transitions to/from a lower power consumption level (Low Power Idle mode) based on link utilization. When no packets are being transmitted, the system goes to Low Power Idle mode to save power. Once packets need to be transmitted, the system returns to normal mode, and does this without changing the link status and without dropping/corrupting frames.

To save power, when the system is in Low Power Idle mode, most of the circuits are disabled, however, the transition time to/from Low Power Idle mode is kept small enough to be transparent to upper layer protocols and applications.

EEE also specifies a negotiation method to enable link partners to determine whether EEE is supported and to select the best set of parameters common to both devices.

Refer to <http://ieee802.org/3/interims/index.html> for more details.

## **7. Switching Regulator**

The RTL8111E incorporates a state-of-the-art switching regulator that requires a well-designed PCB layout in order to achieve good power efficiency and lower the output voltage ripple and input overshoot. Note that the switching regulator 1.0V output pin (REGOUT) must be connected only to DVDD10, AVDD10, and EVDD10 (do not provide this power source to other devices).

*Note: Refer to the separate RTL8111E layout guide for details.*

## 8. Characteristics

### 8.1. Absolute Maximum Ratings

WARNING: Absolute maximum ratings are limits beyond which permanent damage may be caused to the device, or device reliability will be affected. All voltages are specified reference to GND unless otherwise specified.

**Table 18. Absolute Maximum Ratings**

Symbol	Description	Minimum	Maximum	Unit
DVDD33, AVDD33	Supply Voltage 3.3V	-0.3	3.6	V
AVDD10, DVDD10	Supply Voltage 1.0V	-0.3	1.2	V
EVDD10	Supply Voltage 1.0V	-0.3	1.2	V
3.3V DCinput 3.3V DCoutput	Input Voltage Output Voltage	-0.3	3.6	V
1.0V DCinput 1.0V DCoutput	Input Voltage Output Voltage	-0.3	1.2	V
N/A	Storage Temperature	-55	+125	°C

Note: Refer to the most updated schematic circuit for correct configuration.

### 8.2. Recommended Operating Conditions

**Table 19. Recommended Operating Conditions**

Description	Pins	Minimum	Typical	Maximum	Unit
Supply Voltage VDD	DVDD33, AVDD33	3.14	3.3	3.46	V
	AVDD10, DVDD10	0.95	1.0	1.05	V
	EVDD10	0.95	1.0	1.05	V
Ambient Operating Temperature $T_A$	-	0	-	70	°C
Maximum Junction Temperature	-	-	-	125	°C

Note: Refer to the most updated schematic circuit for correct configuration.

### 8.3. Crystal Requirements

**Table 20. Crystal Requirements**

Symbol	Description/Condition	Minimum	Typical	Maximum	Unit
$F_{ref}$	Parallel Resonant Crystal Frequency Tolerance, Fundamental Mode, AT-Cut Type.	-	25	-	MHz
$F_{ref}$ Stability	Parallel Resonant Crystal Frequency Tolerance, Fundamental Mode, AT-Cut Type. $T_a=0^{\circ}\text{C}\sim 70^{\circ}\text{C}$ .	-30	-	+30	ppm
$F_{ref}$ Tolerance	Parallel Resonant Crystal Frequency Tolerance, Fundamental Mode, AT-Cut Type. $T_a=25^{\circ}\text{C}$ .	-50	-	+50	ppm
$F_{ref}$ Duty Cycle	Reference Clock Input Duty Cycle.	40	-	60	%
ESR	Equivalent Series Resistance.	-	-	30	$\Omega$
Jitter	Broadband Peak-to-Peak Jitter <sup>2</sup>	-	-	200	ps
DL	Drive Level.	-	-	0.3	mW

Note1: The CLK source can come from other places in the system, but it must accord with the parameters above.

Note 2: Broadband RMS=9ps; 25KHz to 25MHz RMS=3ps.

### 8.4. Oscillator Requirements

**Table 21. Oscillator Requirements**

Parameter	Condition	Minimum	Typical	Maximum	Unit
Frequency	-	-	25	-	MHz
Frequency Stability	$T_a = 0^{\circ}\text{C}\sim 70^{\circ}\text{C}$	-30	-	+30	ppm
Frequency Tolerance	$T_a = 25^{\circ}\text{C}$	-50	-	+50	ppm
Duty Cycle	-	40	-	60	%
Broadband Peak-to-Peak Jitter <sup>2</sup>	-	-	-	200	ps
Vp-p	-	TBD	TBD	TBD	V
Rise Time	-	-	-	10	ns
Fall Time	-	-	-	10	ns
Operation Temp Range	-	0	-	70	$^{\circ}\text{C}$

Note 1: The CLK source can come from other places in the system, but it must accord with the parameters above.

Note 2: Broadband RMS=9ps; 25KHz to 25MHz RMS=3ps.

## 8.5. Environmental Characteristics

**Table 22. Environmental Characteristics**

Parameter	Range	Units
Storage Temperature	-55 ~ +125	°C
Ambient Operating Temperature	0 ~ 70	°C
Moisture Sensitivity Level (MSL)	Level 3	N/A

## 8.6. DC Characteristics

**Table 23. DC Characteristics**

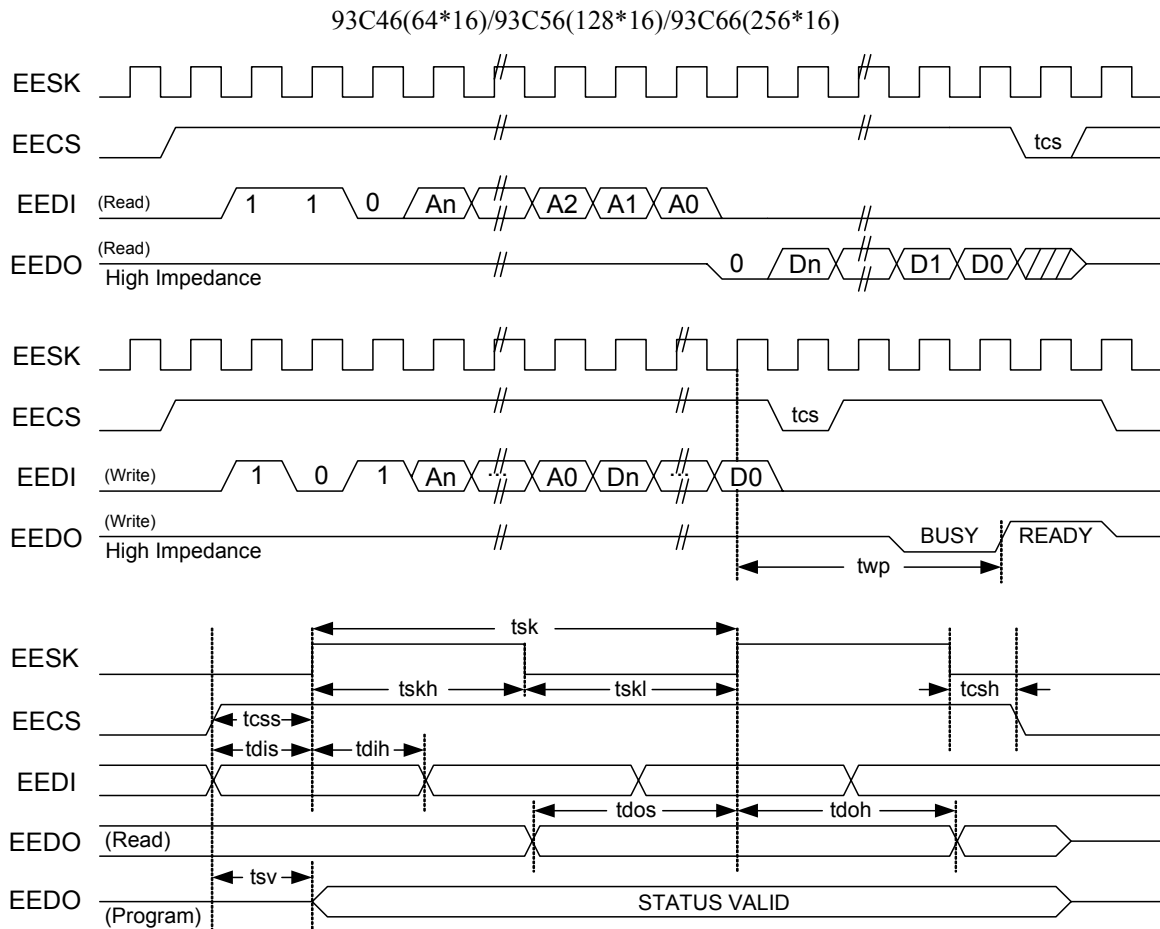
Symbol	Parameter	Conditions	Minimum	Typical	Maximum	Units
DVDD33, AVDD33	3.3V Supply Mean Voltage	-	3.14	3.3	3.46	V
DVDD10, AVDD10	1.0V Supply Mean Voltage	-	0.95	1.0	1.05	V
EVDD10	1.0V Supply Mean Voltage	-	0.95	1.0	1.05	V
V <sub>oh</sub>	Minimum High Level Output Voltage	I <sub>oh</sub> = -4mA	0.9*VDD33	-	VDD33	V
V <sub>ol</sub>	Maximum Low Level Output Voltage	I <sub>ol</sub> = 4mA	0	-	0.1*VDD33	V
V <sub>ih</sub>	Minimum High Level Input Voltage	-	2.0	-	-	V
V <sub>il</sub>	Maximum Low Level Input Voltage	-	-	-	0.8	V
I <sub>in</sub>	Input Current	V <sub>in</sub> = VDD33 or GND	0	-	0.5	μA
I <sub>cc33</sub>	Average Operating Supply Current from 3.3V	At 1Gbps with heavy network traffic	-	70	-	mA
I <sub>cc10</sub>	Average Operating Supply Current from 1.0V	At 1Gbps with heavy network traffic	-	300	-	mA

Note 1: Refer to the latest schematic circuit for correct configuration.

Note 2: All Supply Mean Voltage power noise <±5% of Mean Voltage.

## 8.7. AC Characteristics

### 8.7.1. Serial EEPROM Interface Timing



**Figure 6. Serial EEPROM Interface Timing**

**Table 24. EEPROM Access Timing Parameters**

Symbol	Parameter	EEPROM Type	Min.	Max.	Unit
tcs	Minimum CS Low Time	9346/9356/9366	1000	-	ns
twp	Write Cycle Time	9346/9356/9366	-	10	ms
tsk	SK Clock Cycle Time	9346/9356/9366	4	-	μs
tskh	SK High Time	9346/9356/9366	1000	-	ns
tskl	SK Low Time	9346/9356/9366	1000	-	ns
tcss	CS Setup Time	9346/9356/9366	200	-	ns
tcsh	CS Hold Time	9346/9356/9366	0	-	ns
tdis	DI Setup Time	9346/9356/9366	400	-	ns
tdih	DI Hold Time	9346/9356/9366	400	-	ns
tdos	DO Setup Time	9346/9356/9366	2000	-	ns
tdoh	DO Hold Time	9346/9356/9366	-	2000	ns
tsv	CS to Status Valid	9346/9356/9366	-	1000	ns

## 8.8. PCI Express Bus Parameters

### 8.8.1. Differential Transmitter Parameters

**Table 25. Differential Transmitter Parameters**

Symbol	Parameter	Min	Typical	Max	Units
UI	Unit Interval	399.88	400	400.12	ps
$V_{TX-DIFFp-p}$	Differential Peak to Peak Output Voltage	0.800	-	1.05	V
$V_{TX-DE-RATIO}$	De-Emphasized Differential Output Voltage (Ratio)	-3.0	-3.5	-4.0	dB
$T_{TX-EYE}$	Minimum TX Eye Width	0.75	-	-	UI
$T_{TX-EYE-MEDIAN-}$ $t_{o-MAX-JITTER}$	Maximum Time between The Jitter Median and Maximum Deviation from The Median	-	-	0.125	UI
$T_{TX-RISE}, T_{TX-FALL}$	D+/D- TX Output Rise/Fall Time	0.125	-	-	UI
$V_{TX-CM-ACp}$	RMS AC Peak Common Mode Output Voltage	-	-	20	mV
$V_{TX-CM-DCACTIVE-}$ $IDLEDELTA$	Absolute Delta of DC Common Mode Voltage During L0 and Electrical Idle	0	-	100	mV
$V_{TX-CM-DCLINE-}$ $DELTA$	Absolute Delta of DC Common Mode Voltage between D+ and D-	0	-	25	mV
$V_{TX-IDLE-DIFFp}$	Electrical Idle Differential Peak Output Voltage	0	-	20	mV
$V_{TX-RCV-DETECT}$	The Amount of Voltage Change Allowed During Receiver Detection	-	-	600	mV
$V_{TX-DC-CM}$	The TX DC Common Mode Voltage	0	-	3.6	V
$I_{TX-SHORT}$	TX Short Circuit Current Limit	-	-	90	mA
$T_{TX-IDLE-MIN}$	Minimum Time Spent in Electrical Idle	50	-	-	UI
$T_{TX-IDLE-SETTO-IDLE}$	Maximum Time to Transition to A Valid Electrical Idle After Sending An Electrical Idle Ordered Set	-	-	20	UI
$T_{TX-IDLE-TOTO-}$ $DIFF-DATA$	Maximum Time to Transition to Valid TX Specifications After Leaving An Electrical Idle Condition	-	-	20	UI
$RL_{TX-DIFF}$	Differential Return Loss	10	-	-	dB
$RL_{TX-CM}$	Common Mode Return Loss	6	-	-	dB
$Z_{TX-DIFF-DC}$	DC Differential TX Impedance	80	100	120	$\Omega$
$L_{TX-SKEW}$	Lane-to-Lane Output Skew	-	-	$500+2*UI$	ps
$C_{TX}$	AC Coupling Capacitor	75	-	200	nF
$T_{crosslink}$	Crosslink Random Timeout	0	-	1	ms

Note1: Refer to PCI Express Base Specification, rev.1.1, for correct measurement environment setting of each parameter.

Note2: The data rate can be modulated with an SSC (Spread Spectrum Clock) from +0 to -0.5% of the nominal data rate frequency, at a modulation rate in the range not exceeding 30kHz – 33kHz. The  $\pm 300ppm$  requirement still holds, which requires the two communicating ports be modulated such that they never exceed a total of 600ppm difference.

## 8.8.2. Differential Receiver Parameters

**Table 26. Differential Receiver Parameters**

Symbol	Parameter	Min.	Typical	Max.	Units
UI	Unit Interval	399.88	400	400.12	ps
V <sub>RX-DIFFp-p</sub>	Differential Input Peak-to-Peak Voltage	0.175	-	1.05	V
T <sub>RX-EYE</sub>	Minimum Receiver Eye Width	0.4	-	-	UI
T <sub>RX-EYE-MEDIAN-to-MAX-JITTER</sub>	Maximum Time Between The Jitter Median and Maximum Deviation from The Median	-	-	0.3	UI
V <sub>RX-CM-ACp</sub>	AC Peak Common Mode Input Voltage	-	-	150	mV
RL <sub>RX-DIFF</sub>	Differential Return Loss	10	-	-	dB
RL <sub>RX-CM</sub>	Common Mode Return Loss	6	-	-	dB
Z <sub>RX-DIFF-DC</sub>	DC Differential Input Impedance	80	100	120	Ω
Z <sub>RX-DC</sub>	DC Input Impedance	40	50	60	Ω
Z <sub>RX-HIGH-IMP-DC</sub>	Powered Down DC Input Impedance	200k	-	-	Ω
V <sub>RX-IDLE-DET-DIFFp-p</sub>	Electrical Idle Detect Threshold	65	-	175	mV
T <sub>RX-IDLE-DET-DIFFENTERTIME</sub>	Unexpected Electrical Idle Enter Detect Threshold Integration Time	-	-	10	ms
L <sub>RX-SKEW</sub>	Total Skew	-	-	20	ns

Note: Refer to PCI Express Base Specification, rev.1.1, for correct measurement environment setting of each parameter.

## 8.8.3. REFCLK Parameters

**Table 27. REFCLK Parameters**

Symbol	Parameter	100MHz Input		Units	Note
		Min	Max		
Rise Edge Rate	Rising Edge Rate	0.6	4.0	V/ns	2, 3
Fall Edge Rate	Falling Edge Rate	0.6	4.0	V/ns	2, 3
V <sub>IH</sub>	Differential Input High Voltage	+150	-	mV	2
V <sub>IL</sub>	Differential Input Low Voltage	-	-150	mV	2
V <sub>CROSS</sub>	Absolute Crossing Point Voltage	+250	+550	mV	1, 4, 5
V <sub>CROSS DELTA</sub>	Variation of V <sub>CROSS</sub> Over All Rising Clock Edges	-	+140	mV	1, 4, 9
V <sub>RB</sub>	Ring-Back Voltage Margin	-100	+100	mV	2, 12
T <sub>STABLE</sub>	Time before V <sub>RB</sub> is Allowed	500	-	ps	2, 12
T <sub>PERIOD AVG</sub>	Average Clock Period Accuracy	-300	+2800	ppm	2, 10, 13
T <sub>PERIOD ABS</sub>	Absolute Period (Including Jitter and Spread Spectrum)	9.847	10.203	ns	2, 6
T <sub>CCJITTER</sub>	Cycle to Cycle Jitter	-	150	ps	2
V <sub>MAX</sub>	Absolute Maximum Input Voltage	-	+1.15	V	1, 7
V <sub>MIN</sub>	Absolute Minimum Input Voltage	-	-0.3	V	1, 8

Symbol	Parameter	100MHz Input		Units	Note
		Min	Max		
Duty Cycle	Duty Cycle	40	60	%	2
Rise-Fall Matching	Rising Edge Rate (REFCLK+) to Falling Edge Rate (REFCLK-) Matching	-	20	%	1, 14
Z <sub>C-DC</sub>	Clock Source DC Impedance	40	60	Ω	1, 11

Note1: Measurement taken from single-ended waveform.

Note2: Measurement taken from differential waveform.

Note3: Measured from -150mV to +150mV on the differential waveform (derived from REFCLK+ minus REFCLK-). The signal must be monotonic through the measurement region for rise and fall time. The 300mV measurement window is centered on the differential zero crossing. See Figure 10, page 29.

Note4: Measured at crossing point where the instantaneous voltage value of the rising edge of REFCLK+ equals the falling edge of REFCLK-. See Figure 7, page 28.

Note5: Refers to the total variation from the lowest crossing point to the highest, regardless of which edge is crossing. Refers to all crossing points for this measurement. See Figure 7, page 28.

Note6: Defines as the absolute minimum or maximum instantaneous period. This includes cycle to cycle jitter, relative ppm tolerance, and spread spectrum modulation. See Figure 9, page 28.

Note7: Defined as the maximum instantaneous voltage including overshoot. See Figure 7, page 28.

Note8: Defined as the minimum instantaneous voltage including undershoot. See Figure 7, page 28.

Note9: Defined as the total variation of all crossing voltages of Rising REFCLK+ and Falling REFCLK-. This is the maximum allowed variance in VCROSS for any particular system. See Figure 7, page 28.

Note10: Refer to Section 4.3.2.1 of the PCI Express Base Specification, Revision 1.1 for information regarding ppm considerations.

Note11: System board compliance measurements must use the test load card described in Figure 13, page 30. REFCLK+ and REFCLK- are to be measured at the load capacitors CL. Single ended probes must be used for measurements requiring single ended measurements. Either single ended probes with math or differential probe can be used for differential measurements. Test load CL=2pF.

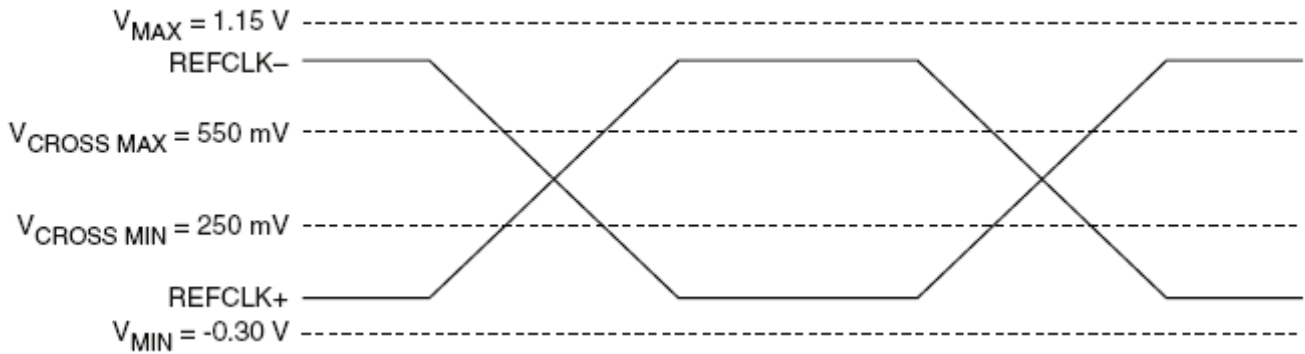
Note12: TSTABLE is the time the differential clock must maintain a minimum ±150mV differential voltage after rising/falling edges before it is allowed to droop back into the VRB ±100mV differential range. See Figure 12, page 29.

Note13: PPM refers to parts per million and is a DC absolute period accuracy specification. 1ppm is 1/1,000,000th of 100.000000MHz exactly, or 100Hz. For 300ppm then we have an error budget of 100Hz/ppm\*300ppm=30kHz. The period is to be measured with a frequency counter with measurement window set to 100ms or greater. The ±300ppm applies to systems that do not employ Spread Spectrum or that use common clock source. For systems employing Spread Spectrum there is an additional 2500ppm nominal shift in maximum period resulting from the 0.5% down spread resulting in a maximum average period specification of +2800ppm.

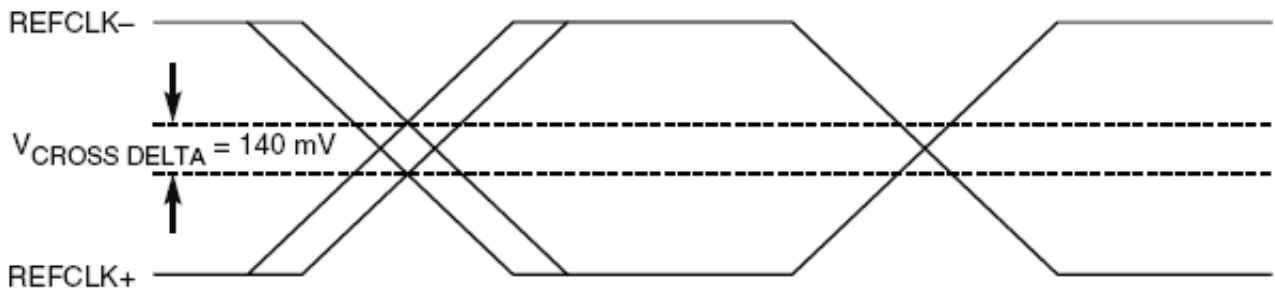
Note14: Matching applies to rising edge rate for REFCLK+ and falling edge rate for REFCLK-. It is measured using a ±75mV window centered on the median cross point where REFCLK+ rising meets REFCLK- falling. The median cross point is used to calculate the voltage thresholds the oscilloscope is to use for the edge rate calculations. The Rise Edge Rate of REFCLK+ should be compared to the Fall Edge Rate of REFCLK-; the maximum allowed difference should not exceed 20% of the slowest edge rate. See Figure 8, page 28.

Note15: Refer to PCI Express Card Electromechanical Specification, rev.1.1, for correct measurement environment setting of each parameter.

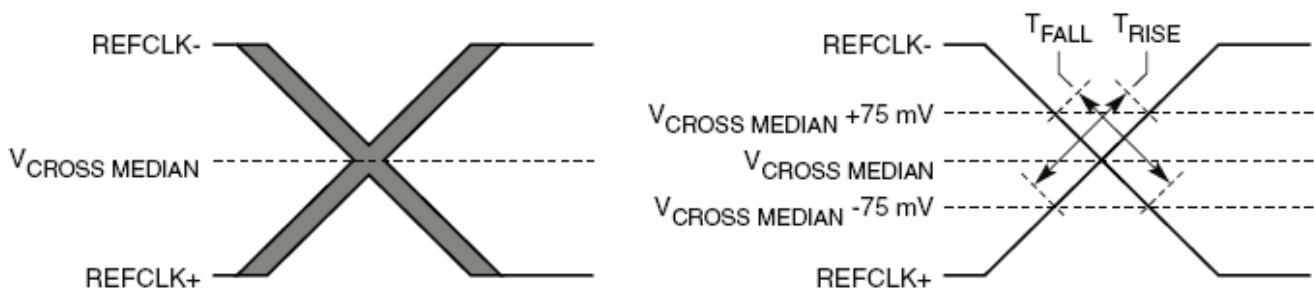




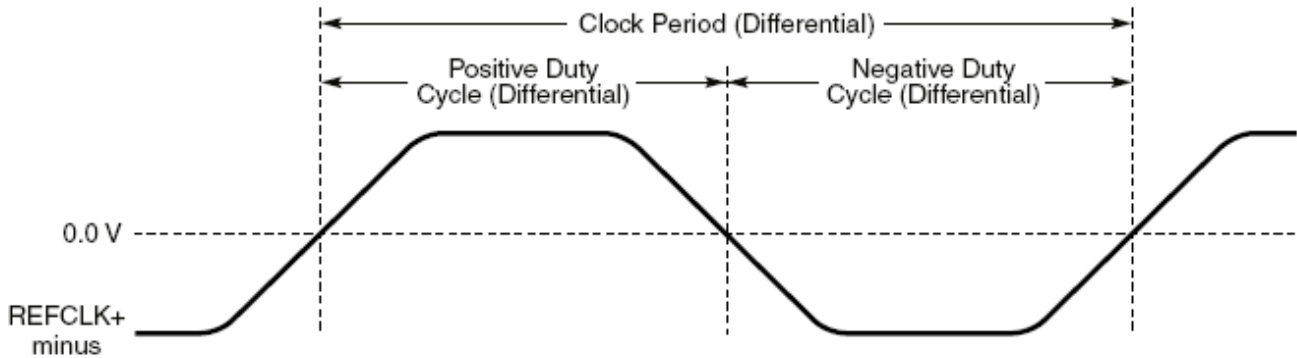
**Figure 7. Single-Ended Measurement Points for Absolute Cross Point and Swing**



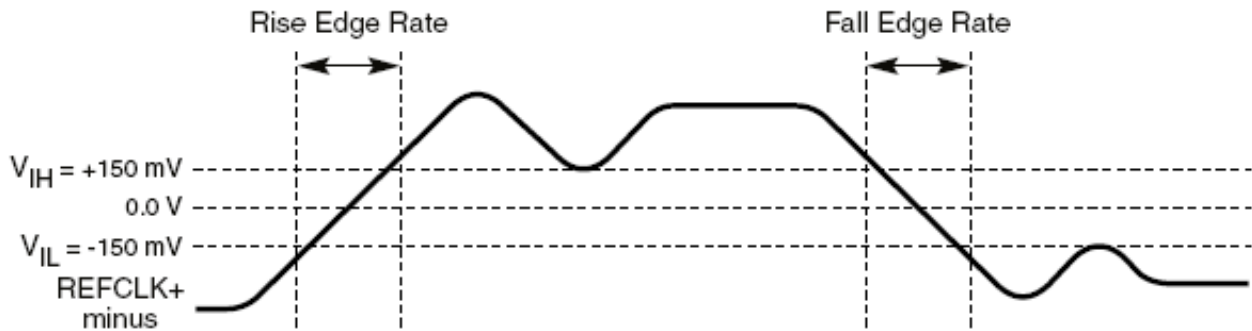
**Figure 8. Single-Ended Measurement Points for Delta Cross Point**



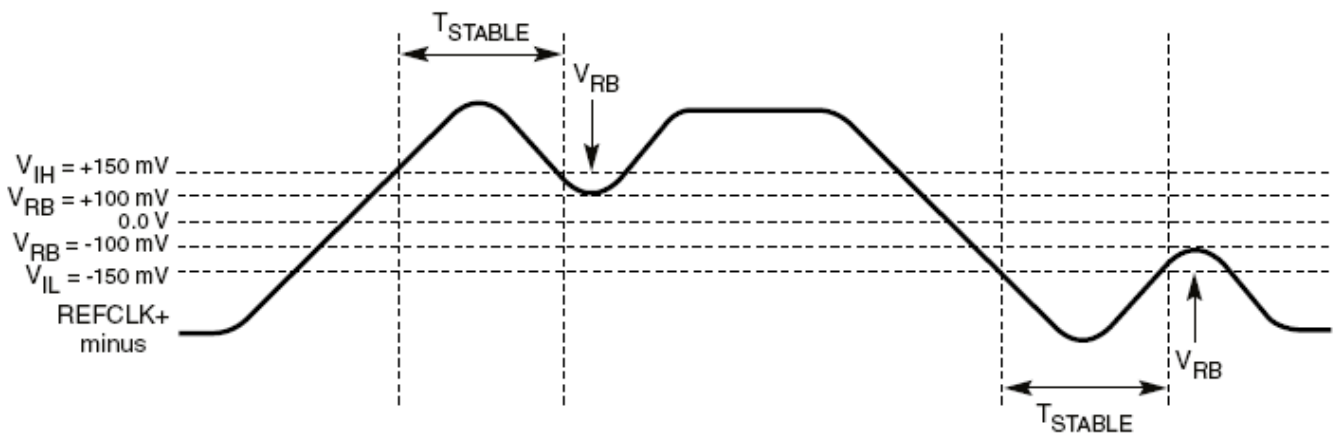
**Figure 9. Single-Ended Measurement Points for Rise and Fall Time Matching**



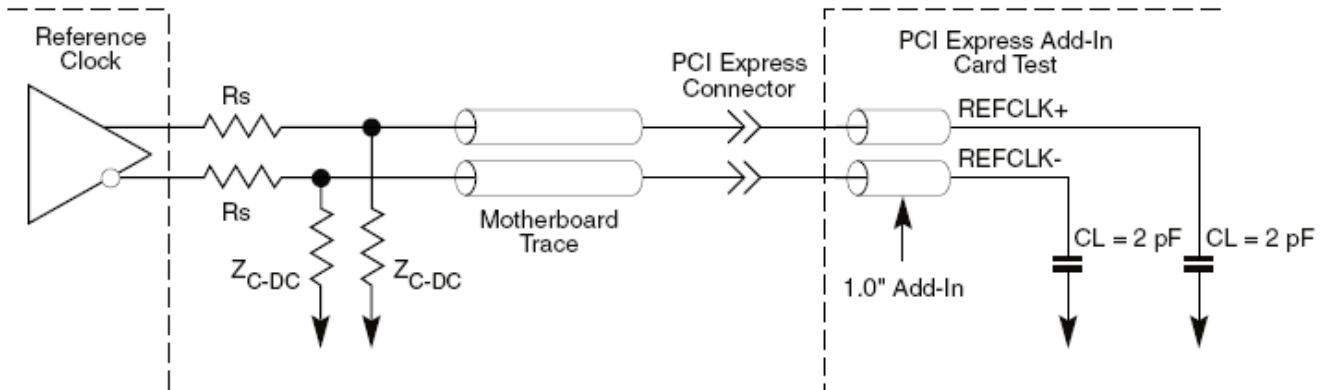
**Figure 10. Differential Measurement Points for Duty Cycle and Period**



**Figure 11. Differential Measurement Points for Rise and Fall Time**



**Figure 12. Differential Measurement Points for Ringback**



**Figure 13. Reference Clock System Measurement Point and Loading**

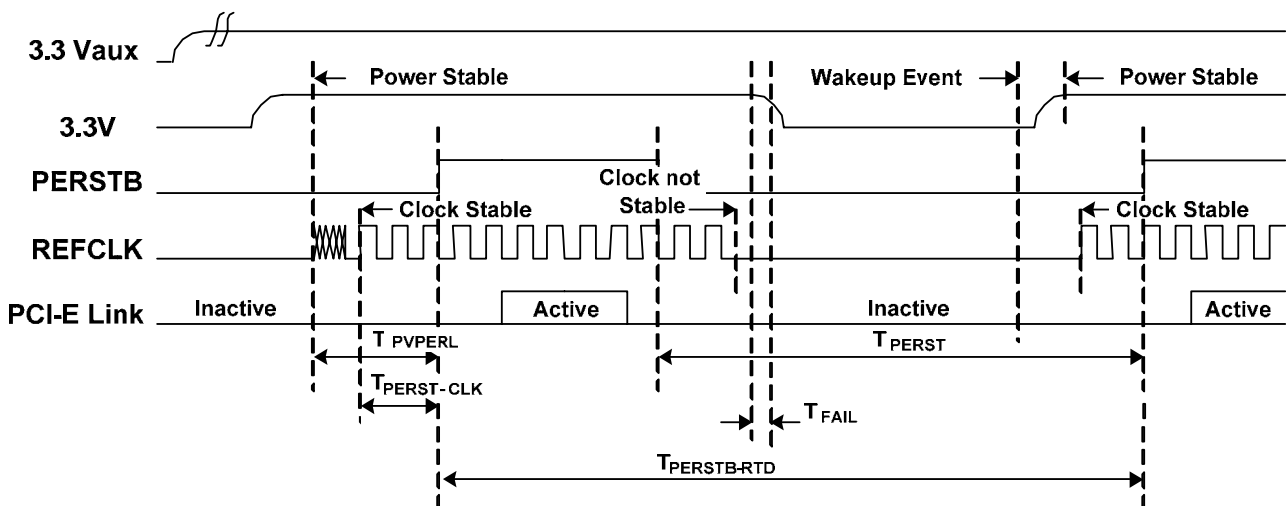
### 8.8.4. Auxiliary Signal Timing Parameters

**Table 28. Auxiliary Signal Timing Parameters**

Symbol	Parameter	Min	Max	Units
$T_{PVPERL}$	Power Stable to PERSTB Inactive	100	-	ms
$T_{PERST-CLK}$	REFCLK Stable before PERSTB Inactive	100	-	$\mu$ s
$T_{PERST}$	PERSTB Active Time	100	-	$\mu$ s
$T_{PERSTB-RTD}$	PERSTB Rising Time Duration	10	-	ms
$T_{FAIL}^*$	Power Level Invalid to PWRGD Inactive	-	500	ns

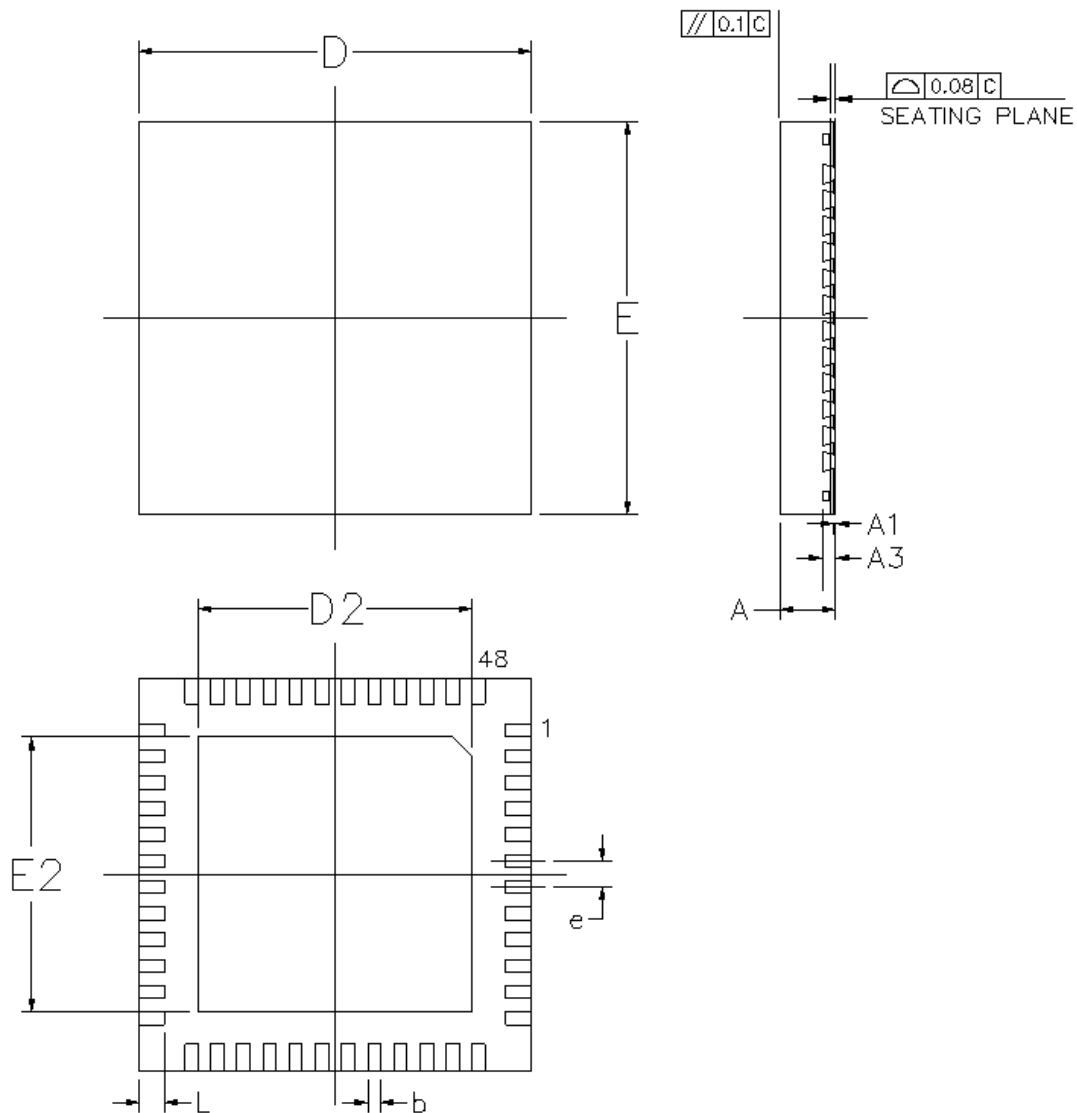
Note 1:  $T_{FAIL}$  means 500 ns (maximum) from the power rail going out of specification (exceeding the specified tolerances by more than 500 mV). Refer to PCI Local Bus Specification rev. 3.0 for further information.  $T_{FAIL}$  can be disregarded when implementation and timing of  $T_{FAIL}$  will not affect any LAN functions.

Note 2: 3.3V means 3.3V main power. The ISOLATEB pin should follow the behavior of the 3.3V main power waveform.



**Figure 14. Auxiliary Signal Timing**

## 9. Mechanical Dimensions



Symbol	Dimension in mm			Dimension in inch		
	Min	Nom	Max	Min	Nom	Max
A	0.75	0.85	1.00	0.030	0.034	0.039
A <sub>1</sub>	0.00	0.02	0.05	0.000	0.001	0.002
A <sub>3</sub>	0.20REF			0.008REF		
b	0.15	0.20	0.25	0.006	0.008	0.010
D/E	6.00BSC			0.236BSC		
D2/E2	4.15	4.4	4.65	0.163	0.173	0.183
e	0.40BSC			0.016BSC		
L	0.30	0.40	0.50	0.012	0.016	0.020

Note 1: CONTROLLING DIMENSION: MILLIMETER (mm).

Note 2: REFERENCE DOCUMENT: JEDEC MO-220.

## 10. Ordering Information

**Table 29. Ordering Information**

Part Number	Package	Status
RTL8111E-VL-CG	48-Pin QFN 'Green' Package	

*Note: See page 4 for package identification information.*

---

**Realtek Semiconductor Corp.****Headquarters**

No. 2, Innovation Road II

Hsinchu Science Park, Hsinchu 300, Taiwan

Tel.: +886-3-578-0211. Fax: +886-3-577-6047

[www.realtek.com](http://www.realtek.com)