

Power Schottky rectifier

Features

- High current capability
- Avalanche rated
- Low forward voltage drop current
- High frequency operation

Description

This dual center tap schottky rectifier is suited for high frequency switch mode power supplies.

Packaged in TO-247 and TO-220AB, this device provides desktop SMPS designers with a low forward voltage drop device, and reduced leakage current, with the objective of making the application compliant with environmental care standards, or suitable for 80+ requirements.

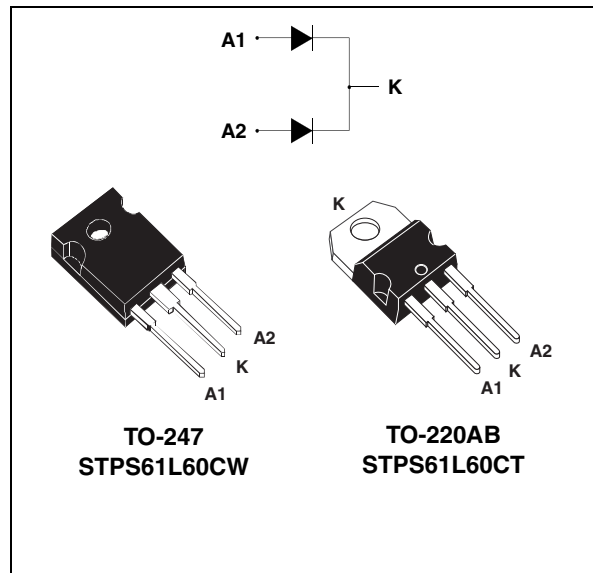
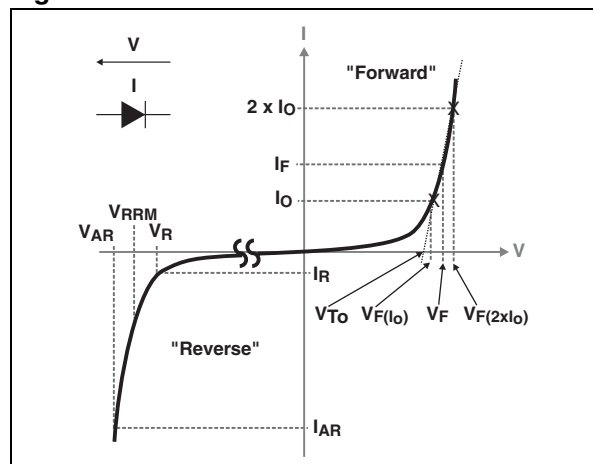

Table 1. Device summary

$I_{F(AV)}$	2 x 30 A
V_{RRM}	60 V
T_j (max)	150 °C
V_F (typ)	0.560 V

Figure 1. Electrical characteristics (a)



- a. V_{ARM} and I_{ARM} must respect the reverse safe operating area defined in [Figure 12](#) V_{AR} and I_{AR} are pulse measurements ($t_p < 1 \mu s$). V_R , I_R , V_{RRM} and V_F , are static characteristics

1 Characteristics

Table 2. Absolute ratings (limiting values per diode at 25 °C unless otherwise specified)

Symbol	Parameter			Value	Unit
V _{RRM}	Repetitive peak reverse voltage			60	V
I _{F(RMS)}	Forward rms voltage			50	A
I _{F(AV)}	Average forward current δ = 0.5	T _c = 125 °C T _c = 120 °C	Per diode Per device	30 60	A
I _{FSM}	Surge non repetitive forward current	t _p = 10 ms sinusoidal	T0-247 T0-220AB	530 400	A
P _{ARM}	Repetitive peak avalanche power	t _p = 1 μs T _j = 25 °C		11500	W
V _{ARM} ⁽¹⁾	Maximum repetitive peak avalanche voltage	t _p < 1 μs T _j < 150 °C, I _{AR} < 43 A		80	V
V _{ASM} ⁽¹⁾	Maximum single pulse peak avalanche voltage	t _p < 1 μs T _j < 150 °C, I _{AR} < 43 A		80	V
T _{stg}	Storage temperature range			-65 to + 175	°C
T _j	Maximum operating junction temperature ⁽²⁾			150	°C

1. Refer to [Figure 12](#)

2. $\frac{dP_{tot}}{dT_j} < \frac{1}{R_{th(j-a)}}$ condition to avoid thermal runaway for a diode on its own heatsink

Table 3. Thermal resistances

Symbol	Parameter			Value	Unit
R _{th(j-c)}	Junction to case	TO-247	Per diode Total	0.95 0.6	°C/W
		TO-220AB	Per diode Total	1.1 0.7	
R _{th(c)}	Coupling	TO-247		0.25	
		TO-220AB		0.3	

When the diodes 1 and 2 are used simultaneously :

$$\Delta T_j(\text{diode 1}) = P(\text{diode1}) \times R_{th(j-c)}(\text{Per diode}) + P(\text{diode 2}) \times R_{th(c)}$$

Table 4. Static electrical characteristics (per diode)

Symbol	Parameter	Test conditions		Min.	Typ.	Max.	Unit
$I_R^{(1)}$	Reverse leakage current	$T_j = 25\text{ }^\circ\text{C}$	$V_R = V_{RRM}$	-	-	0.8	mA
		$T_j = 125\text{ }^\circ\text{C}$		-	150	350	
$V_F^{(2)}$	Forward voltage drop	$T_j = 25\text{ }^\circ\text{C}$	$I_F = 5\text{ A}$	-	0.360	-	V
		$T_j = 125\text{ }^\circ\text{C}$	$I_F = 5\text{ A}$	-	0.255	-	
		$T_j = 25\text{ }^\circ\text{C}$	$I_F = 15\text{ A}$	-	0.460	0.540	
		$T_j = 125\text{ }^\circ\text{C}$	$I_F = 15\text{ A}$	-	0.415	0.480	
		$T_j = 25\text{ }^\circ\text{C}$	$I_F = 30\text{ A}$	-	0.580	0.660	
		$T_j = 125\text{ }^\circ\text{C}$	$I_F = 30\text{ A}$	-	0.560	0.620	

1. Pulse test: $t_p = 5\text{ ms}$, $\delta < 2\%$

2. Pulse test: $t_p = 380\text{ }\mu\text{s}$, $\delta < 2\%$

To evaluate the conduction losses use the following equation: $P = 0.44 \times I_{F(AV)} + 0.006 \times I_F^2(RMS)$

Figure 2. Average forward power dissipation vs. average forward current (per diode)

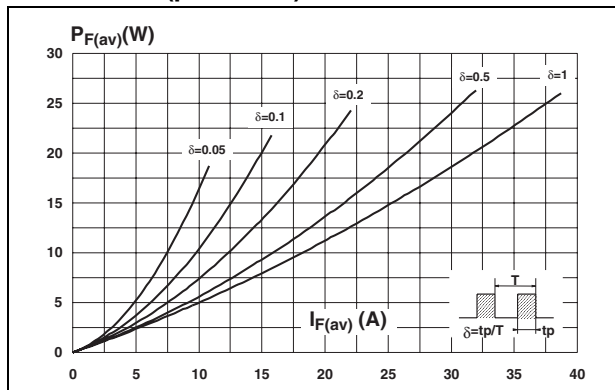

Figure 3. Average forward current vs. ambient temperature (delta = 0.5, per diode)

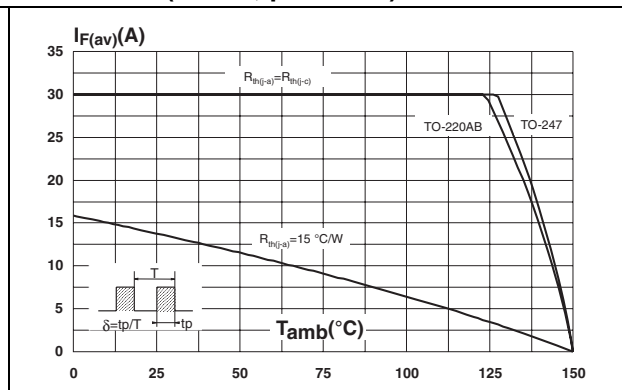

Figure 4. Normalized avalanche power derating vs. pulse duration

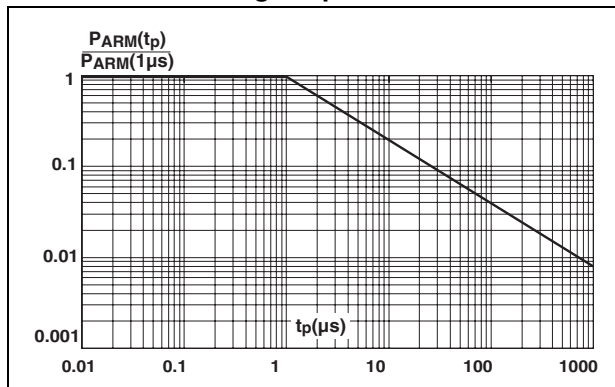

Figure 5. Normalized avalanche power derating vs. junction temperature

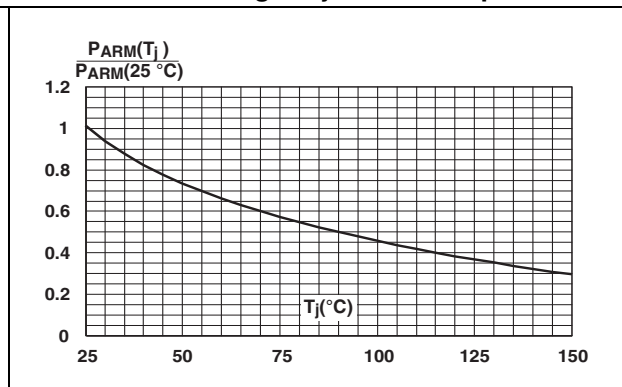

Figure 6. Non repetitive surge peak forward current vs. overload duration (max. values, per diode, TO-247)

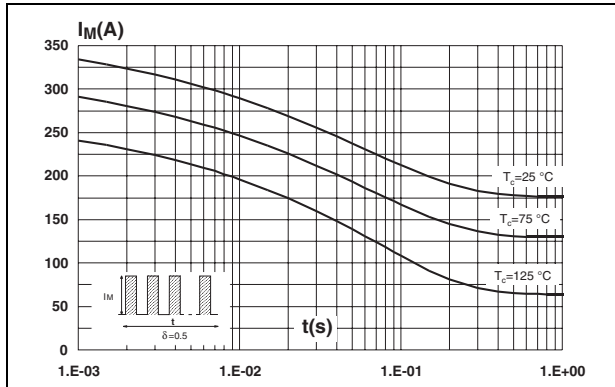

Figure 7. Non repetitive surge peak forward current vs. overload duration (max. values, per diode, TO-220AB)

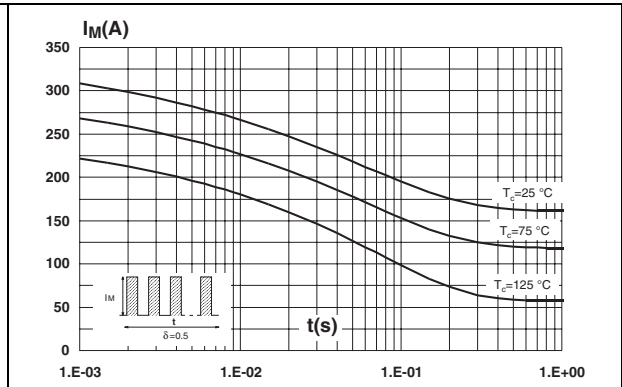

Figure 8. Relative variation of thermal impedance junction to case vs. pulse duration

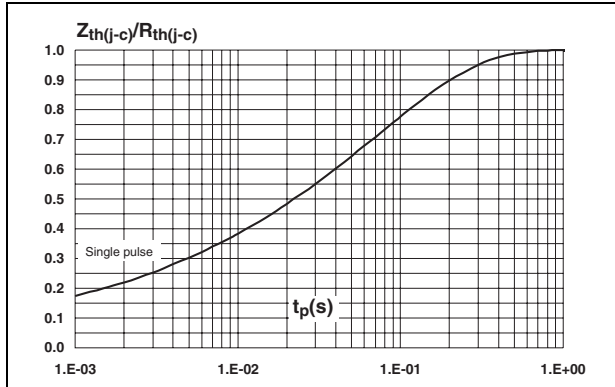

Figure 9. Reverse leakage current vs. reverse voltage applied (typical values, per diode)

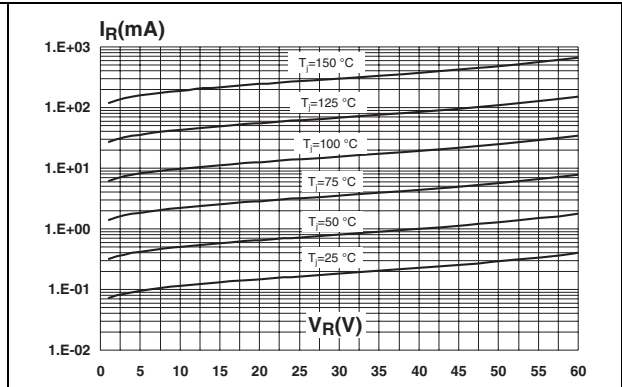

Figure 10. Junction capacitance vs. reverse voltage applied (typical values, per diode)

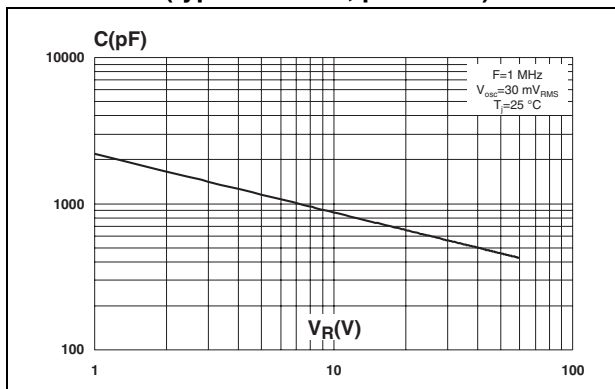

Figure 11. Forward voltage drop vs. forward current (per diode)

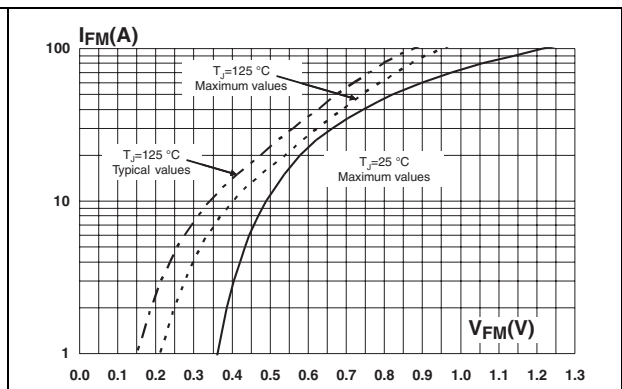
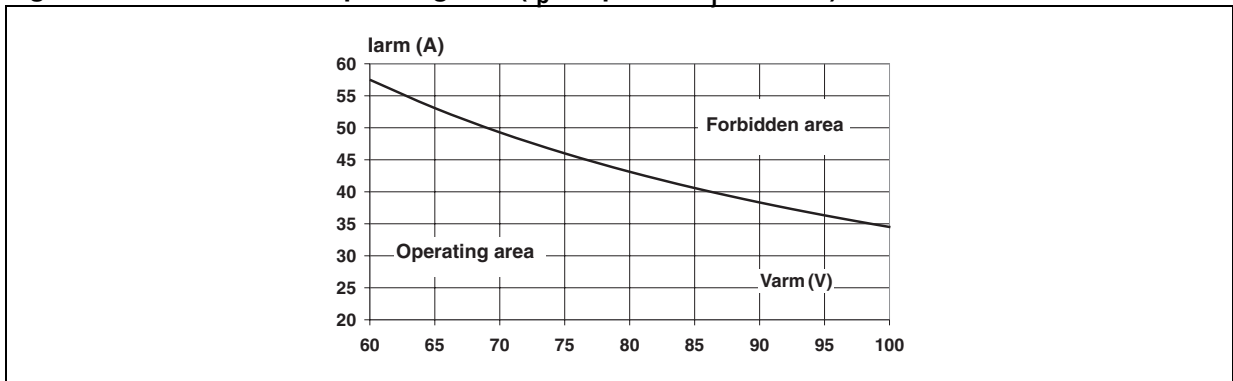

Figure 12. Reverse safe operating area ($t_p < 1 \mu\text{s}$ and $T_j < 150 \text{ }^\circ\text{C}$)

2 Package information

- Epoxy meets UL94, V0
- Cooling method: conduction
- Torque value:
 - TO-247 - 0.55 N·m recommended, 1.0 N·m maximum
 - TO-220AB - 0.4 to 0.6 N·m

In order to meet environmental requirements, ST offers these devices in different grades of ECOPACK® packages, depending on their level of environmental compliance. ECOPACK® specifications, grade definitions and product status are available at: www.st.com. ECOPACK® is an ST trademark.

Table 5. TO-247 dimensions

Ref.	Dimensions			
	Millimeters		Inches	
	Min.	Max.	Min.	Max.
A	4.85	5.15	0.191	0.203
A1	2.20	2.60	0.086	0.102
b	1.00	1.40	0.039	0.055
b1	2.00	2.40	0.078	0.094
b2	3.00	3.40	0.118	0.133
c	0.40	0.80	0.015	0.031
D ⁽¹⁾	19.85	20.15	0.781	0.793
E	15.45	15.75	0.608	0.620
e	5.45 typ.		0.215 typ.	
L	14.20	14.80	0.559	0.582
L1	3.70	4.30	0.145	0.169
L2	18.50 typ.		0.728 typ.	
ØP ⁽²⁾	3.55	3.65	0.139	0.143
ØR	4.50	5.50	0.177	0.217
S	5.50 typ.		0.216 typ.	

1. Dimension D plus gate protrusion does not exceed 20.5 mm
2. Resin thickness around the mounting hole is not less than 0.9 mm

Table 6. TO-220AB dimensions

Ref.	Dimensions			
	Millimeters		Inches	
	Min.	Max.	Min.	Max.
A	4.40	4.60	0.173	0.181
C	1.23	1.32	0.048	0.051
D	2.40	2.72	0.094	0.107
E	0.49	0.70	0.019	0.027
F	0.61	0.88	0.024	0.034
F1	1.14	1.70	0.044	0.066
F2	1.14	1.70	0.044	0.066
G	4.95	5.15	0.194	0.202
G1	2.40	2.70	0.094	0.106
H2	10	10.40	0.393	0.409
L2	16.4 typ.		0.645 typ.	
L4	13	14	0.511	0.551
L5	2.65	2.95	0.104	0.116
L6	15.25	15.75	0.600	0.620
L7	6.20	6.60	0.244	0.259
L9	3.50	3.93	0.137	0.154
M	2.6 typ.		0.102 typ.	
Diam.	3.75	3.85	0.147	0.151

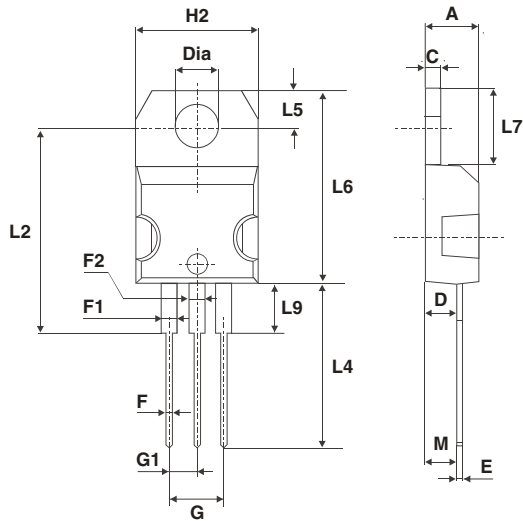

3 Ordering information

Table 7. Ordering information

Order code	Marking	Package	Weight	Base qty	Delivery mode
STPS61L60CW	STPS61L60CW	TO-247	4.4 g	30	Tube
STPS61L60CT	STPS61L60CT	TO-220AB	2.23 g	30	Tube

4 Revision history

Table 8. Document revision history

Date	Revision	Changes
18-May-2009	1	Initial release.
29-Jun-2010	2	Added Figure 1 and Figure 12 . Added parameters V_{ARM} and V_{ASM} to Table 2 . Updated Table 5 .

Please Read Carefully:

Information in this document is provided solely in connection with ST products. STMicroelectronics NV and its subsidiaries ("ST") reserve the right to make changes, corrections, modifications or improvements, to this document, and the products and services described herein at any time, without notice.

All ST products are sold pursuant to ST's terms and conditions of sale.

Purchasers are solely responsible for the choice, selection and use of the ST products and services described herein, and ST assumes no liability whatsoever relating to the choice, selection or use of the ST products and services described herein.

No license, express or implied, by estoppel or otherwise, to any intellectual property rights is granted under this document. If any part of this document refers to any third party products or services it shall not be deemed a license grant by ST for the use of such third party products or services, or any intellectual property contained therein or considered as a warranty covering the use in any manner whatsoever of such third party products or services or any intellectual property contained therein.

UNLESS OTHERWISE SET FORTH IN ST'S TERMS AND CONDITIONS OF SALE ST DISCLAIMS ANY EXPRESS OR IMPLIED WARRANTY WITH RESPECT TO THE USE AND/OR SALE OF ST PRODUCTS INCLUDING WITHOUT LIMITATION IMPLIED WARRANTIES OF MERCHANTABILITY, FITNESS FOR A PARTICULAR PURPOSE (AND THEIR EQUIVALENTS UNDER THE LAWS OF ANY JURISDICTION), OR INFRINGEMENT OF ANY PATENT, COPYRIGHT OR OTHER INTELLECTUAL PROPERTY RIGHT.

UNLESS EXPRESSLY APPROVED IN WRITING BY AN AUTHORIZED ST REPRESENTATIVE, ST PRODUCTS ARE NOT RECOMMENDED, AUTHORIZED OR WARRANTED FOR USE IN MILITARY, AIR CRAFT, SPACE, LIFE SAVING, OR LIFE SUSTAINING APPLICATIONS, NOR IN PRODUCTS OR SYSTEMS WHERE FAILURE OR MALFUNCTION MAY RESULT IN PERSONAL INJURY, DEATH, OR SEVERE PROPERTY OR ENVIRONMENTAL DAMAGE. ST PRODUCTS WHICH ARE NOT SPECIFIED AS "AUTOMOTIVE GRADE" MAY ONLY BE USED IN AUTOMOTIVE APPLICATIONS AT USER'S OWN RISK.

Resale of ST products with provisions different from the statements and/or technical features set forth in this document shall immediately void any warranty granted by ST for the ST product or service described herein and shall not create or extend in any manner whatsoever, any liability of ST.

ST and the ST logo are trademarks or registered trademarks of ST in various countries.

Information in this document supersedes and replaces all information previously supplied.

The ST logo is a registered trademark of STMicroelectronics. All other names are the property of their respective owners.

© 2010 STMicroelectronics - All rights reserved

STMicroelectronics group of companies

Australia - Belgium - Brazil - Canada - China - Czech Republic - Finland - France - Germany - Hong Kong - India - Israel - Italy - Japan - Malaysia - Malta - Morocco - Philippines - Singapore - Spain - Sweden - Switzerland - United Kingdom - United States of America

www.st.com

Mouser Electronics

Authorized Distributor

Click to View Pricing, Inventory, Delivery & Lifecycle Information:

[STMicroelectronics:](#)

[STPS61L60CT](#) [STPS61L60CW](#)